

Serial ATA International Organization

Version 1.0
6 February 2020

Serial ATA Interoperability Program Revision 1.6 Keysight MOI for SATA RSG Tests

This document is provided "AS IS" and without any warranty of any kind, including, without limitation, any express or implied warranty of non-infringement, merchantability or fitness for a particular purpose. In no event shall SATA-IO or any member of SATA-IO be liable for any direct, indirect, special, exemplary, punitive, or consequential damages, including, without limitation, lost profits, even if advised of the possibility of such damages.

This material is provided for reference only. The Serial ATA International Organization does not endorse the vendor equipment outlined in this document.

TABLE OF CONTENTS

TABLE OF CONTENTS.....2

GROUP 1: RSG REQUIREMENTS.....9

TEST RSG-01: GEN1 (1.5Gb/s) RECEIVER JITTER TOLERANCE TEST (NORMATIVE) 10

TEST RSG-02: GEN2 (3.0Gb/s) RECEIVER JITTER TOLERANCE TEST (NORMATIVE)11

TEST RSG-03: GEN3 (6.0Gb/s) RECEIVER JITTER TOLERANCE TEST (NORMATIVE) 12

TEST RSG-04: (RESERVED) 13

TEST RSG-05: RECEIVER STRESS TEST AT +350PPM (NORMATIVE)..... 14

TEST RSG-06: RECEIVER STRESS TEST WITH SSC (INFORMATIVE) 15

APPENDICES16

APPENDIX A – GENERAL RESOURCE REQUIREMENTS 17

APPENDIX B – SSG CALIBRATION PROCEDURE (USING KEYSIGHT DSO8XXXX/9XXXXX REAL-TIME DSO AS THE JMD)..... 21

APPENDIX C – SSG CALIBRATION PROCEDURE (USING KEYSIGHT N4903A/B J-BERT AS THE JMD) (INFORMATIVE) 27

APPENDIX D – SSG CALIBRATION PROCEDURE (USING KEYSIGHT 86100C DCA-J AS THE JMD) (INFORMATIVE) 29

APPENDIX E – USING THE KEYSIGHT J-BERT N4903A/B (FW v4.91 OR LATER) AS THE STRESSED SIGNAL GENERATOR (SSG)..... 34

APPENDIX F - USING THE KEYSIGHT J-BERT M8020A AS THE STRESSED SIGNAL GENERATOR (SSG)..... 37

APPENDIX G – USING THE KEYSIGHT 81133/4A PULSE/PATTERN GENERATOR AS THE STRESSED SIGNAL GENERATOR (SSG)..... 40

APPENDIX H – USING THE KEYSIGHT N4219B SERIAL ATA PROBE AS THE FRAME ERROR DETECTOR 43

APPENDIX I – USING THE CRESCENT HEART SOFTWARE SATA-II PROBE AS THE FRAME ERROR DETECTOR 49

APPENDIX J – SUGGESTED INITIAL AMPLITUDE AND DJ/RJ SETTINGS FOR VARIOUS SSG SETUPS (OBSOLETE) 51

APPENDIX K – USING THE KEYSIGHT N5990A TEST AUTOMATION SOFTWARE OPTION 103 (A.K.A. VALIFRAME) 52

APPENDIX L – USING THE KEYSIGHT 81133/4A PULSE/PATTERN GENERATOR AND 81150A PULSE FUNCTION ARBITRARY NOISE GENERATOR AS THE STRESSED SIGNAL GENERATOR (SSG) 58

APPENDIX M – USING THE KEYSIGHT J-BERT N4903B WITH OPTION A02 AS THE FRAME ERROR DETECTOR 61

APPENDIX N – USING THE KEYSIGHT J-BERT M8020A WITH OPTION 0S2 AS THE FRAME ERROR DETECTOR 65

Serial ATA Logo Working Group

MODIFICATION RECORD

(REVISIONS FOR 1.5 INTEROP PROGRAM)

2020 February 6 (Version 1.0) UPDATES TO SUPPORT r1.6 UTD CHANGES

Vincent Yew (Keysight):

Cover Page: Changed document UTD revision
All chapters: Changed UTD version references

2015 May 13 (Version 1.0) Added J-BERT M8020A

Thorsten Götzelmann (Keysight):

Corrections in new M8020A sections

2015 May 13 (Version 0.9RC2) Added J-BERT M8020A

Thorsten Götzelmann (Keysight):

No changes in calibration and test methodologies to version 0.9RC

2013 June 6 (Version 0.9RC) UPDATES TO SUPPORT r1.5 UTD CHANGES

Thorsten Götzelmann (Agilent):

No changes to version 0.8

2013 May 2 (Version 0.8) UPDATES TO SUPPORT r1.5 UTD CHANGES

Thorsten Götzelmann (Agilent):

All chapters: Changed UTD version references
RSG chapters: Removed N4915A-005 switches
Appendix A: Updated equipment list
Added note for gen3u host
Appendix B: Removed eye height pre-jitter calibration step
Added CIC s4p embedding for gen3u host
Changed scope triggering for eye height measurement

2011 May 13 (Version 1.0RC) UPDATES TO SUPPORT r1.4.2 UTD CHANGES

Michael Herz (Agilent):

Cover Page: Changed document version
Appendix A: Added reference to software which is needed when using J-BERT as a BIST configuration tool

2011 May 6 (Version 0.80) UPDATES TO SUPPORT r1.4.2 UTD CHANGES

Michael Herz (Agilent):

Cover Page: Changed document version
All chapters: replaced all instances of "framed COMP" by "FCOMP"
Appendix A: Added Agilent J-BERT as BIST configuration tool
Appendix B: Updated amplitude calibration procedure
Appendix C & D: Added a note that these informative appendices have not yet been updated.
Appendix L: Minor modifications. Updated screen shot.

2010 December 8 (Version 1.1) Final Approved Release

Michael Herz (Agilent):

Cover Page: Changed document version number to 1.1
Appendix A.1: Updated test fixture product numbers

2010 August 6 (Revision 2, Version 1.0RC) Changed the version number to 1.0RC

Michael Herz (Agilent):

Cover Page: Changed document version number to 1.0RC

2010 April 7 (Revision 2, Version 0.90) Changed the version number to 0.9 after Logo approval vote

Michael Herz (Agilent):

Cover Page: Changed document version number to 0.9

2010 Mar 16 (Revision 2, Version 0.80) NEW EQUIPMENT ADDED

Serial ATA Logo Working Group

Michael Herz (Agilent): Cover Page: Moved document version number back to 0.8
Appendix L added
Added Wilder Technologies test fixture

2009 Sept 17 (Version 1.00) FINAL APPROVED r1.4 RELEASE

Andy Baldman (UNH-IOL): Cover Page: Updated document version number to 1.00 (i.e., removed 'RC').

2009 August 8 (Version 1.00RC1) APPROVED WG RELEASE CANDIDATE

Andy Baldman (UNH-IOL): Cover Page: Changed document version number to 1.00RC.
RSG-05: Removed Informative designation (made test normative), and corrected Discussion to state that test applies to all products (Gen1/2/3)
Appendix A: Updated Figures A-1 and A-2 with better looking diagrams, and eliminated section A.3 and Figure A-3, as they were no longer needed. (Redundant with new Figure A-1)
Appendix A: Added Serialtek SAS/SATA Analyzer as Error Counter option.
Appendices C+E: (Editorial): Changed all J-BERT model references to N4903A to N4903A/B
Appendix K: Changed status to Normative (i.e., removed informative), and replaced Figure K-1 with new Figure showing SSC setup.
Appendix L: Deleted Appendix for using J-BERT as Error Counter

2009 June 3 (Version 0.91) ADDITIONAL UPDATES TO SUPPORT r1.4 UTD CHANGES

Andy Baldman (UNH-IOL): Cover Page: Changed document version number to 0.91.
RSG-01: Added discussion under 'Possible Problems' section to discuss the issue and detection of devices with improperly functioning BIST-L modes.
Appendix B: Added final cal step to calibrate amplitude using 1E-12 BER eye height, according to UTD requirements.
Appendix I: Made obsolete, as the values don't really apply anymore.

2009 May 27 (Version 0.87) ADDITIONAL UPDATES TO SUPPORT r1.4 UTD CHANGES

Andy Baldman (UNH-IOL): Cover Page: Changed document version number to 0.87.
Appendix A: Removed Figure A-1b showing synchronous Gen3 setup (no longer supported). (Also renamed Figure A-1a back to A-1, and added minor edits to first paragraph above Figure A-1, just to sync text to figure.)
Appendix A: Added entries (with part numbers) to Table A-1 for ISI Channel and Gen3 TTC's.
Test RSG-03: Corrected test time to 2mins 30secs.
Tests RSG-05 and -06: Removed "asynchronous" from the test names (as per UTD). Also, changed min number of observed frames from 6 to 18, per UTD change.
Appendix B: Modified SSG calibration procedure to agree with UTD updates.

2009 Mar 28 (Version 0.80) MAJOR UPDATE TO SUPPORT r1.4 UTD ADDITIONS

Andy Baldman (UNH-IOL): Cover Page: Changed document version number to 0.80.
Entire Document: Updated all test names to r1.4 UTD names, and also updated all UTD references to reflect proper r1.4 section numbers.
All tests: Clarified for each test that the test applies to products supporting operation at that speed.
Added new tests RSG-04, RSG-05, and RSG-06.
Appendices A+K: Removed several references to the 81150 as being informative for 1.3.
Appendix A: Replaced previous Figure A-1 with two new figures (A-1a and A-1b) showing general setups for Gen1/2, and Gen3, respectively. (Also added minor edits to first paragraph above Figure A-1a, just to sync with new figures)

Serial ATA Logo Working Group

(REVISIONS FOR 1.3 INTEROP PROGRAM)

2008 Dec 10 (Version 1.10) MAJOR UPDATE TO SUPPORT BIT ERROR RATIO TESTER

Michael Herz (Agilent): Cover Page: Updated document version number to 1.10
Added Appendix L
Suggest to remove the Informative status from the 81150A due to showing correlation during IW #6

2008 Sep 24 (Version 1.00) FINAL APPROVED r1.3 RELEASE

Andy Baldman (UNH-IOL): Cover Page: Updated document version number to 1.00 (i.e., removed 'RC').

2008 May 29 (Version 1.00RC) MINOR UPDATE FOLLOWING MAY 29 LOGO WG REVIEW AND APPROVAL

Andy Baldman (UNH-IOL): RSG-01: Removed footnote in procedure Step 11 regarding the previous J-BERT limitation for Gen1/62MHz.
Appendix A: Added footnote to Table A-1 stating that v4.91 FW or newer is required to use J-BERT.
Appendix E: Removed Informative status from appendix Title.
Appendix E: Added text to appendix Title and Discussion stating v4.91 FW or newer is required to use J-BERT.

2008 Feb 10 (Version 0.90) MINOR UPDATE FOLLOWING FEB 8 LOGO WG REVIEW

Andy Baldman (UNH-IOL): Appendix A: Added note to bottom of Table A-1 denoting current status of 81150A generator as informative.

2008 Feb 07 (Version 0.85) MAJOR UPDATE TO SUPPORT REVISION 1.3 INTEROP PROGRAM

Andy Baldman (UNH-IOL): Entire Document: Updated all UTD references to point to r1.3 UTD.
Entire Document: Updated all spec references to point to SATA v2.6.
RSG-01 and RSG-02: Added 5MHz DJ test case to procedure.
Appendix A: Added Agilent 81150A DJ/RJ Signal Generator to Table A-1.
Appendix A: Added Agilent N4915A Serial Bus Switches to Table A-1.
Appendix A: Added CHS TF-eSATA-NE-ZP fixture to Table A-1.
Appendix A: Updated Figure A-1 to show new setup using N4915A Serial Bus Switches.
Appendix A: Modified Figure A-2 to make RJ + DJ sources generic.
Appendix A: Replaced A.3 and Figure A-3 (cal setup diagram) with modified Valifram setup.
Appendix A: Replaced all references to power splitters with Serial Bus Switches
Appendix B: Changed wording in B.2 to point to Figure A-1 for setup.
Appendix B: Added gen1m/2m levels to B.2 amplitude calibration procedure.
Appendix B: Changed B.5 jitter text to indicate inclusion of m-level PUTs.
Appendix B: Added 5MHz to B.7 list of DJ frequencies.
Appendix C: Filled out C.5 (previously TBD) with TJ/DJ measurement procedure.
Appendix C: Added 5MHz to C.7 list of DJ frequencies.
Appendix D: Added gen1m/2m levels to D.2 and D.7.
Appendix E: Deleted reference to resistive splitters in E.1.
Appendix F: Changed Figure F-1 to only show SSG components.
Appendix F: Removed splitters from Figure F-1, and deleted text from F.1 discussing splitter use.
Added new informative Appendix K for using Agilent 81150A as DJ/RJ source.

Serial ATA Logo Working Group

(PREVIOUS REVISIONS FOR 1.2 INTEROP PROGRAM)

2007 Oct 24 (Version 1.00) FINAL APPROVED r1.2 RELEASE

Andy Baldman (UNH-IOL): Cover Page: Updated document version number to 1.00.

2007 Jul 12 (Version 1.00RC1) EDITORIAL UPDATE FOLLOWING 12JUL2007 RC APPROVAL

Andy Baldman (UNH-IOL): Cover Page: Updated document version number to 1.00RC.

2007 Jun 07 (Version 0.92) ADDITIONAL UPDATES, POST-IW3

Andy Baldman (UNH-IOL): Acknowledgements page: Added Hermann Stehling, for Bitfeye contributions of automation software.
RSG-01 and RSG-02: Added note at bottom of procedure to cover premature test abortion for cases when excessive errors are observed (i.e., >1000) for any test case, as per the UTD.
Appendix A: Added Agilent SMA cables and part numbers to equipment list.
Appendix A: Added model numbers of suitable equivalent Noisecom sources to equipment list.
Appendix A: Added E4432B sine source to equipment list as suitable DJ source.
Appendix I: Added initial starting settings for using E4432B as DJ source with 81134A SSG.
Added new Appendix (Appendix J), for Bitfeye automation software.

2007 Apr 28 (Version 0.90) MINOR UPDATES IN RESPONSE TO 17APR2007 REVIEW.

Andy Baldman (UNH-IOL): Cover Page: Updated SATA logo to trademarked version, and added CHS Frame Error Detector.
Entire Document: Changed Noisecom noise source model name from UFX-7110 to PNG-7110.
Appendix A: Changed amplitude procedure BACK to using LBP lone 0/1, rather than ALIGN minimum amplitude bits.
Renamed Appendix H to Appendix I.
Added new Appendix H for Crescent Heart Software Frame Error Detector.

2007 Apr 16 (Version 0.88) ADDITIONAL MAJOR UPDATES

Andy Baldman (UNH-IOL): Entire Document: Updated all DJ references to .270UI, from .320UI.
Entire Document: Removed all references to using 14dB splitters. (50/50 splitters are preferred, for better return loss and matching.)
Appendix A: Changed amplitude procedure to use ALIGN Minimum Amplitude Bit instead of LBP lone bit.
Appendix D: Cleaned up many typos, and moved J-BERT-specific SSG info into Appendix E.

2007 Apr 08 (Version 0.87) MAJOR UPDATE FOR REVISION 1.2 INTEROP PROGRAM

Andy Baldman (UNH-IOL): Entire document: Updated all UTD and MOI references to reflect Program Revision 1.2
RSG-01/02: Changed DJ frequencies from 5/10/62MHz to 10/33/62MHz per UTD updates.
Appendix A: Added 14dB pickoff tees to Table A-1, and changed Figure A-3 to a block diagram.
Appendix B: Completely overhauled, adding procedure for amplitude calibration using isolated Lone 1.
Appendices C, D, E: Made informative.
Appendix F: Major rewrite to include procedure for using Noisecom PNG-7110 noise source.

(PREVIOUS REVISIONS FOR 1.0 AND 1.1 INTEROP PROGRAMS)

2006 Nov 23 (Version 0.85) ADDITIONAL UPDATES

Michael Herz (Agilent): Added contents on an 81134A-based setup.

2006 Nov 22 (Version 0.84) ADDITIONAL MAJOR UPDATES

Andy Baldman (UNH-IOL): Created separate appendices for J-BERT, DCA-J, and real-time DSO calibration.
Created separate appendix for using 81134A-based setup (instead of J-BERT) for jitter generation.
Renumbered all Appendices as a result of above changes.
RSG-01/02: Replaced 'Pattern Generator' with 'SSG', to make more modular, and hardware independent.

2006 Nov 13 (Version 0.83) FIRST MAJOR UPDATE

Andy Baldman (UNH-IOL): Updated title page to new revision 1.1 naming conventions.
Added procedures to Appendix B to support multiple Jitter Measurement Devices for calibration purposes.
Added Appendix C for SATA Probe setup and configuration.

2006 Sep 24 (Version 0.81) INITIAL DRAFT RELEASE

Andy Baldman (UNH-IOL): Initial Release

Serial ATA Logo Working Group

ACKNOWLEDGMENTS

The Serial ATA Logo Working Group would like to acknowledge the efforts of the following individuals in the development of this document:

David Woolf
Andy Baldman
Dr. Michael Herz
Hermann Stehling
Vincent Yew
John Calvin

UNH InterOperability Lab
UNH InterOperability Lab
Agilent Technologies
Bitifeye Digital Test Solutions
Keysight Technologies
Keysight Technologies

djwoolf@iol.unh.edu
aab@iol.unh.edu
michael_herz@agilent.com
hermann.stehling@bitifeye.com
vincent.yew@keysight.com
john.calvin@keysight.com

INTRODUCTION

The tests contained in this document are organized in order to simplify the identification of information related to a test, and to facilitate in the actual testing process. Tests are separated into groups, primarily in order to reduce setup time in the lab environment, however the different groups typically also tend to focus on specific aspects of product functionality.

The test definitions themselves are intended to provide a high-level description of the motivation, resources, procedures, and methodologies specific to each test. Formally, each test description contains the following sections:

Purpose

The purpose is a brief statement outlining what the test attempts to achieve. The test is written at the functional level.

References

This section specifies all reference material *external* to the test suite, including the specific subclauses references for the test in question, and any other references that might be helpful in understanding the test methodology and/or test results. External sources are always referenced by a bracketed number (e.g., [1]) when mentioned in the test description. Any other references in the test description that are not indicated in this manner refer to elements within the test suite document itself (e.g., “Appendix 6.A”, or “Table 6.1.1-1”)

Resource Requirements

The requirements section specifies the test hardware and/or software needed to perform the test. This is generally expressed in terms of minimum requirements, however in some cases specific equipment manufacturer/model information may be provided.

Last Modification

This specifies the date of the last modification to this test.

Discussion

The discussion covers the assumptions made in the design or implementation of the test, as well as known limitations. Other items specific to the test are covered here as well.

Test Setup

The setup section describes the initial configuration of the test environment. Small changes in the configuration should not be included here, and are generally covered in the test procedure section (next).

Procedure

The procedure section of the test description contains the systematic instructions for carrying out the test. It provides a cookbook approach to testing, and may be interspersed with observable results.

Observable Results

This section lists the specific observables that can be examined by the tester in order to verify that the PUT is operating properly. When multiple values for an observable are possible, this section provides a short discussion on how to interpret them. The determination of a pass or fail outcome for a particular test is generally based on the successful (or unsuccessful) detection of a specific observable.

Possible Problems

This section contains a description of known issues with the test procedure, which may affect test results in certain situations. It may also refer the reader to test suite appendices and/or other external sources that may provide more detail regarding these issues.

GROUP 1: RSG REQUIREMENTS

Overview:

This group of tests verifies receiver functionality under stressed-signal conditions, for the purposes of performing SATA-IO Interoperability Program testing. These tests are limited to functionality which are covered by tests RSG-01 through RSG-06 (Section 2.17 of the *Serial ATA Interoperability Program Unified Test Document Revision 1.6*), and do not provide comprehensive coverage of all receiver tolerance requirements defined by the SATA Revision 3.0 standard.

Serial ATA Logo Working Group

Test RSG-01: Gen1 (1.5Gb/s) Receiver Jitter Tolerance Test (Normative)

Purpose: To verify that the receiver of the Product Under Test (PUT) can operate without error under stressed signal conditions while operating at 1.5Gb/s.

References:

- [1] SATA Interoperability Program Revision 1.6 Unified Test Document, Section 3.18.3
- [2] SATA Interoperability Program Revision 1.6 Unified Test Document, Section 5.6 (FCOMP Pattern)

Resource Requirements: See Appendix A.

Last Modification: May 02, 2013

Discussion:

Reference [1] specifies the basic requirements for Receiver Jitter Tolerance testing for the purposes of the SATA-IO Interoperability Program. These requirements are a subset of the complete set of requirements defined in the SATA standard. Note that this test is applicable to products that support operation at 1.5Gb/s.

Test Setup: See Appendix A.

Test Procedure:

Note this test procedure assumes the user has already performed the initial system setup and calibration procedures outlined in Appendices A-K of this document.

- 1) Connect the PUT to the test system as outlined in Appendix A.
- 2) Configure the Stressed Signal Generator (SSG) to send the FCOMP pattern [2] at 1.5Gb/s, and turn the output of the generator OFF (i.e., disable all signal output).
- 3) Configure the PUT for BIST-L operation at 1.5Gb/s using the BIST Configuration Tool.
- 4) Turn the output of the SSG ON, but with jitter disabled (i.e., clean pattern with nominal SATA amplitude).
- 5) Verify using the Frame Error Counter that the PUT is properly looping back the unstressed FCOMP pattern data without error.
- 6) Configure the SSG for Sinusoidal DJ at a frequency of 5MHz, with the proper DJ, RJ, and Amplitude values determined during the cal procedure for 1.5Gb/s operation. Enable jitter generation on the SSG output, and turn the SSG output ON.
- 7) Reset the counter on the Frame Error Counter.
- 8) Run the test for 10 minutes and record the number of frame errors detected by the Frame Error Counter.
- 9) Repeat steps 8-10 for the 10, 33, and 62 MHz sinusoidal jitter frequencies.

Note that for any jitter frequency test case, if ‘excessive’ errors are observed (i.e., >1000), the test may be prematurely aborted, and a failing result assigned for that test case.

Observable Results:

- For all 4 sinusoidal jitter frequencies, the number of frame errors observed should be zero.

Possible Problems: If a product fails the 62.5MHz DJ test case, it is possible that a problem may exist with the PUT’s BIST mode, in that it may not be operating in a retimed loopback, but rather an analog loopback. (Also known as BIST-F.) To check for this, vary the magnitude of the 62MHz DJ sent from the SSG, and measure the DJ at the PUT output. If the measured DJ tracks the applied DJ, the PUT is not operating properly in BIST-L, and should be investigated. (Note that the RSG tests require a properly functioning BIST-L mode from the PUT in order to be considered valid.)

Serial ATA Logo Working Group

Test RSG-02: Gen2 (3.0Gb/s) Receiver Jitter Tolerance Test (Normative)

Purpose: To verify that the receiver of the Product Under Test (PUT) can operate without error under stressed signal conditions while operating at 3.0Gb/s.

References:

- [1] SATA Interoperability Program Revision 1.6 Unified Test Document, Section 3.18.4
- [2] SATA Interoperability Program Revision 1.6 Unified Test Document, Section 5.6 (FCOMP Pattern)

Resource Requirements: See Appendix A.

Last Modification: May 02, 2013

Discussion:

Reference [1] specifies the basic requirements for Receiver Jitter Tolerance testing for the purposes of the SATA-IO Interoperability Program. These requirements are a subset of the complete set of requirements defined in the SATA standard. Note that this test applies to products that support operation at 3.0Gb/s.

Test Setup: See Appendix A.

Test Procedure:

Note this test procedure assumes the user has already performed the initial system setup and calibration procedures outlined in Appendices A-K of this document.

- 1) Connect the PUT to the test system as outlined in Appendix A.
- 2) Configure the Stressed Signal Generator (SSG) to send the FCOMP pattern [2] at 3.0Gb/s, and turn the output of the generator OFF (i.e., disable all signal output).
- 3) Configure the PUT for BIST-L operation at 3.0Gb/s using the BIST Configuration Tool.
- 4) Turn the output of the SSG ON, but with jitter disabled (i.e., clean pattern with nominal SATA amplitude).
- 5) Verify using the Frame Error Counter that the PUT is properly looping back the unstressed FCOMP pattern data without error.
- 6) Configure the SSG for Sinusoidal DJ at a frequency of 5MHz, with the proper DJ, RJ, and Amplitude values determined during the cal procedure for 3.0Gb/s operation. Enable jitter generation on the SSG output, and turn the SSG output ON.
- 7) Reset the counter on the Frame Error Counter.
- 8) Run the test for 5 minutes and record the number of frame errors detected by the Frame Error Counter.
- 9) Repeat steps 8-10 for the 10, 33, and 62 MHz sinusoidal jitter frequencies.

Note that for any jitter frequency test case, if 'excessive' errors are observed (i.e., >1000), the test may be prematurely aborted, and a failing result assigned for that test case.

Observable Results:

- For all jitter frequencies, the number of frame errors observed should be zero.

Possible Problems: None

Serial ATA Logo Working Group

Test RSG-03: Gen3 (6.0Gb/s) Receiver Jitter Tolerance Test (Normative)

Purpose: To verify that the receiver of the Product Under Test (PUT) can operate without error under stressed signal conditions while operating at 6.0Gb/s.

References:

- [1] SATA Interoperability Program Revision 1.6 Unified Test Document, Section 3.18.5
- [2] SATA Interoperability Program Revision 1.6 Unified Test Document, Section 5.6 (FCOMP Pattern)

Resource Requirements: See Appendix A.

Last Modification: May 02, 2013

Discussion: Reference [1] specifies the basic requirements for Receiver Jitter Tolerance testing for the purposes of the SATA-IO Interoperability Program. These requirements are a subset of the complete set of requirements defined in the SATA standard. Note that this test applies only to products that support operation at 6.0Gb/s.

Test Setup: See Appendix A.

Test Procedure:

Note this test procedure assumes the user has already performed the initial system setup and calibration procedures outlined in Appendices A-K of this document.

- 1) Connect the PUT to the test system as outlined in Appendix A.
- 2) Configure the Stressed Signal Generator (SSG) to send the FCOMP pattern [2] at 6.0Gb/s, and turn the output of the generator OFF (i.e., disable all signal output).
- 3) Configure the PUT for BIST-L operation at 6.0Gb/s using the BIST Configuration Tool.
- 4) Turn the output of the SSG ON, but with jitter disabled (i.e., clean pattern with nominal SATA amplitude).
- 5) Verify using the Frame Error Counter that the PUT is properly looping back the unstressed FCOMP pattern data without error.
- 6) Configure the SSG for Sinusoidal DJ at a frequency of 5MHz, with the proper DJ, RJ, and Amplitude values determined during the cal procedure for 6.0Gb/s operation. Enable jitter generation on the SSG output, and turn the SSG output ON.
- 7) Reset the counter on the Frame Error Counter.
- 8) Run the test for 2 minutes and 30 seconds, and record the number of frame errors detected by the Frame Error Counter.
- 9) Repeat steps 8-10 for the 10, 33, and 62 MHz sinusoidal jitter frequencies.

Note that for any jitter frequency test case, if ‘excessive’ errors are observed (i.e., >1000), the test may be prematurely aborted, and a failing result assigned for that test case.

Observable Results:

- For all jitter frequencies, the number of frame errors observed should be zero.

Possible Problems: None

Serial ATA Logo Working Group

Test RSG-04: (Reserved)

Purpose: (This test is reserved for future development, per the SATA-IO UTD.)

References:

[1] SATA Interoperability Program Revision 1.6 Unified Test Document, Section 3.18.6

Resource Requirements: N/A.

Last Modification: March 28, 2009

Discussion: N/A.

Test Setup: N/A.

Test Procedure: N/A.

Observable Results:

- N/A.

Possible Problems: N/A.

Serial ATA Logo Working Group

Test RSG-05: Receiver Stress Test at +350ppm (Normative)

Purpose: To verify that the receiver of the Product Under Test (PUT) can operate without error under stressed signal conditions while operating at the maximum allowed static frequency offset.

References:

- [1] SATA Interoperability Program Revision 1.6 Unified Test Document, Section 3.18.7
- [2] SATA Interoperability Program Revision 1.6 Unified Test Document, Section 5.6 (FCOMP Pattern)

Resource Requirements: See Appendix A.

Last Modification: May 02, 2013

Discussion:

The SATA-IO Unified Test Document specifies the basic requirements for Receiver Jitter Tolerance testing for the purposes of the SATA-IO Interoperability Program. These requirements are a subset of the complete set of requirements defined in the SATA standard, and include a test which verifies the ability of a receiver to operate at a fixed frequency offset from the ideal nominal operating rate[1]. Note that this test applies to all products (Gen1, Gen2, and Gen3), however the test is performed at the 1.5Gb/s operating rate.

Test Setup: See Appendix A.

Test Procedure:

Note this test procedure assumes the user has already performed the initial system setup and calibration procedures outlined in Appendices A-K of this document.

- 1) Connect the PUT to the test system as outlined in Appendix A.
- 2) Configure the Stressed Signal Generator (SSG) to send the FCOMP pattern [2] at 1.5Gb/s and a 0 ppm frequency offset, and turn the output of the generator OFF (i.e., disable all signal output).
- 3) Configure the PUT for BIST-L operation at 1.5Gb/s using the BIST Configuration Tool.
- 4) Turn the output of the SSG ON, but with jitter disabled (i.e., clean pattern with nominal SATA amplitude).
- 5) Verify using the Frame Error Counter that the PUT is properly looping back the unstressed FCOMP pattern data without error.
- 6) Configure the SSG for Sinusoidal DJ at a frequency of 62MHz, with the proper DJ, RJ, and Amplitude values determined during the cal procedure for 1.5Gb/s operation. Enable jitter generation on the SSG output, and turn the SSG output ON.
- 7) Verify using the Frame Error Counter that the PUT is properly looping back the stressed FCOMP pattern data without error.
- 8) Adjust the frequency offset of the SSG to a rate of 1.5Gb/s+350ppm.
- 9) Verify using the Frame Error Counter that the PUT is still properly looping back the stressed FCOMP pattern data without error.

Note that this test definition specifies that observation only needs to be performed over “a minimum of 18 successive iterations of the FCOMP pattern”[1]. Therefore for all of the equipment setups defined in this MOI, observations made over several seconds of test time are more than sufficient to satisfy this requirement.

Observable Results:

- For all cases, the number of frame errors observed should be zero.

Possible Problems: None

Serial ATA Logo Working Group

Test RSG-06: Receiver Stress Test With SSC (Informative)

Purpose: To verify that the receiver of the Product Under Test (PUT) can operate without error under stressed signal conditions including Spread Spectrum Clocking (SSC).

References:

- [1] SATA Interoperability Program Revision 1.6 Unified Test Document, Section 3.18.8
- [2] SATA Interoperability Program Revision 1.6 Unified Test Document, Section 5.6 (FCOMP Pattern)

Resource Requirements: See Appendix A.

Last Modification: May 02, 2013

Discussion:

The SATA-IO Unified Test Document specifies the basic requirements for Receiver Jitter Tolerance testing for the purposes of the SATA-IO Interoperability Program. These requirements are a subset of the complete set of requirements defined in the SATA standard, and include a test which verifies the ability of a receiver to operate in the presence of Spread Spectrum Clocking (SSC)[1]. Note that this test applies to all products (Gen1, Gen2, and Gen3), however the test is performed at the 1.5Gb/s operating rate.

Test Setup: See Appendix A.

Test Procedure:

Note this test procedure assumes the user has already performed the initial system setup and calibration procedures outlined in Appendices A-K of this document.

- 1) Connect the PUT to the test system as outlined in Appendix A.
- 2) Configure the Stressed Signal Generator (SSG) to send the FCOMP pattern [2] at 1.5Gb/s and a 0 ppm frequency offset, and turn the output of the generator OFF (i.e., disable all signal output).
- 3) Configure the PUT for BIST-L operation at 1.5Gb/s using the BIST Configuration Tool.
- 4) Turn the output of the SSG ON, but with jitter disabled (i.e., clean pattern with nominal SATA amplitude).
- 5) Verify using the Frame Error Counter that the PUT is properly looping back the unstressed FCOMP pattern data without error.
- 6) Configure the SSG for Sinusoidal DJ at a frequency of 62MHz, with the proper DJ, RJ, and Amplitude values determined during the cal procedure for 1.5Gb/s operation. Enable jitter generation on the SSG output, and turn the SSG output ON.
- 7) Verify using the Frame Error Counter that the PUT is properly looping back the stressed FCOMP pattern data without error.
- 8) Configure the SSG for an SSC profile which spreads from -350ppm to -5350ppm (relative to 1.5Gb/s), and enable the SSC on the generated output signal
- 9) Verify using the Frame Error Counter that the PUT is still properly looping back the stressed FCOMP pattern data without error.

Note that this test definition specifies that observation only needs to be performed over “a minimum of 18 successive iterations of the FCOMP pattern”[1]. Therefore for all of the equipment setups defined in this MOI, observations made over several seconds of test time are more than sufficient to satisfy this requirement.

Observable Results:

- The number of frame errors observed should be zero.

Possible Problems: None

APPENDICES

Overview:

Test suite appendices are intended to provide additional low-level technical detail pertinent to specific tests contained in this test suite. These appendices often cover topics that are outside of the scope of the standard, and are specific to the methodologies used for performing the measurements in this test suite. Appendix topics may also include discussion regarding a specific interpretation of the standard (for the purposes of this test suite), for cases where a particular specification may appear unclear or otherwise open to multiple interpretations.

Test suite appendices are considered informative supplements, and pertain solely to the test definitions and procedures contained in this test suite.

Serial ATA Logo Working Group

Appendix A – General Resource Requirements

Purpose: To define the hardware/software requirements for performing the tests defined in this document.

References: None.

Last Modification: May 02, 2013

Discussion:

A.1 - Introduction

In order to perform receiver jitter tolerance testing on SATA transceivers, several pieces of equipment are needed. The primary functional components are as follows:

Component	Function	Device/Model
Stressed Signal Generator (SSG)	Generates jittered/stressed test signal	Keysight J-BERT N4903A(v4.91 FW or newer)* or Keysight J-BERT N4903B or Keysight J-BERT M8020A or Keysight 81133A (one channel) or 81134A (two channels) Pattern Generator, plus external DJ/RJ modulation sources (see below).
RJ Noise Source	Used as RJ modulation source (when using 81134A as SSG.)	Keysight 81150A or NoiseCom PNG-7110. (Equivalent models include UFX/PNG-7107/08/09/10/12, and NC-6107/08/09/10/12)
DJ Sine Source	Used as DJ modulation source (when using 81134A as SSG.)	Keysight 81150A** or 33250A or E4432B signal generator
SSC Source	Used as SSC modulation source (when using 81134A as SSG.)	Keysight MXG N5181A Analog Signal Generator + 33kHz triangular wfm source (33210) or Keysight MXG N5182A Vector Signal Generator or ESG E4438C Vector Signal Generator (New Appendix)
BIST Configuration Tool	Used to enable BIST-L loopback mode of PUT	PC running Ulink DriveMaster software or Keysight J-BERT N4903A with Keysight 11742A DC blocking caps on outputs and using JBISTGUI (download from http://www.iol.unh.edu/services/testing/sata/tools.php) or Keysight J-BERT N4903B with option 002 installed and using JBISTGUI (download from http://www.iol.unh.edu/services/testing/sata/tools.php) or Keysight J-BERT M8020A with option M8041A-0G2 and N5990A-303 SATA Link Training Suite
Jitter Measurement Device (JMD)	Used to verify/calibrate SSG output.	Keysight Infiniium 90000A/X/Q DSA Series High-Performance Oscilloscope with at least 13GHz BW (Keysight 86100C w 54754A, or Keysight N4903 J-BERT may be used for informative purposes only.)
3-Way, 50/50 Resistive Power Splitter (PS)	Used to combine DJ+RJ modulation sources when using 81134A as SSG	Keysight 11636B or equivalent (1 needed)

Serial ATA Logo Working Group

	Used to combine Data and AuxData outputs of J-BERT N4903B and J-BERT M8020A when being used as BIST Configuration Tool	Keysight 11636B (3.5mm) / C (2.4mm) or equivalent (2 needed)
Hi-Speed Serial Bus Switch (HSS)	Used to mux BIST Generator in and out of test setup. Not needed if JBISTGUI is used for BIST L	Keysight N4915A-005 (2 needed)
Frame Error Counter (FERC)	Used to detect and count frame errors on PUT TX	Keysight 168xx or 169xx Logic Analyzer with 16910, 16911, or 16950 module, and N4219B SATA Probe. (Gen1/2 only) or Crescent Heart Software SATA-II Probe (Gen1/2 only) or Finisar Xgig-C042 (Four Slot Chassis) Xgig-B860Sc (6 Gb/s SAS/SATA Wide Port Blade with mini SAS connectors, 16 GB memory, Link Extender) Xgig-S86AS (Wide-Port 6Gb/s SAS/SATA Analyzer Function Key (8 ports / 4 links)) Performance Monitor Software or Serialtek Pro Series SAS/SATA Analyzer, or Micro Series SAS/SATA Analyzer, or MicroLite Series SAS/SATA Analyzer or Keysight J-BERT N4903B with option A02 or Keysight M8020A with option M8041A-0S2
Transition Time Converters (TTC) (Gen1 & Gen2 Test Setups)	Used to create SSG risetime of 100ps (20/80%)	Keysight N15435A (2 needed)
Transition Time Converters (TTC) (Gen3 Test Setup)	Used to create SSG risetime of 62-75ps (20/80%)	Picosecond Pulse Labs Part#: 5915-110-100PS (2 needed)
ISI Channel	Generates calibrated amounts of Inter-Symbol Interference (ISI)	Keysight N4915-60001 SATA ISI Channel (1 needed)
SATA-to-SMA Test Fixture	Used to convert SATA interface of PUT to SMA, for test instrument connections	<u>iSATA:</u> Comax P/N H303000204A, or Crescent Heart TF-SATA-NE-XP, or Keysight N5421-26401, or Wilder Technologies SATA-TPA-R, SATA-TPA-P, SATA22-TPA-P, SATA22-TPA-R, SA2.5-TPA-P, SA2.5-TPA-R or ICT-LANTO TF-1P11, TF-1P21, TF-1R11, TF-1R21, TF-1R31 <u>eSATA:</u>

Serial ATA Logo Working Group

		Crescent Heart TF-eSATA-NE-ZP, or ICT-LANTO TF-2P11, TF-2R11 <u>mSATA:</u> Wilder Technologies MSATA-TPA-P, MSATA-TPA-R
SMA Test Cables	Used for all connections, except J-BERT N4903B channel add with 11636C power divider	Keysight 15442-61601 (includes 4 cables) 14 total cables recommended.
2.4mm matched pair cables short	Used for J-BERT N4903B channel add with power divider 11636C	N4915A-014 (2 sets needed for channel add)
SMA matched pair cables short	Used for J-BERT M8020A channel add with power divider 11636B	M8048A-801 (2 sets needed for channel add)
3.5mm DC blocks	Used for AC coupling	11742A (4 DC blocks required for M8020A, 2 DC blocks required for N4903B and 81134A)

* Starting with firmware v4.91, all jitter frequencies are supported by J-BERT.

Table A-1: Summary of Test Hardware Requirements

A.2- Basic Test Setup

Figure A-1a shows a Test Setup that supports both disconnect and non-disconnect PUT's, for tests RSG-01, -02, -03, -05, and -06. The BIST-L Source is multiplexed into the TX and RX pairs of the PUT using one N4914A-005 Serial Bus Switch, and one pair of power dividers, which allow non-disconnect-supporting PUT's to be put into BIST-L using the BIST-L Source, then be sent the FCOMP test pattern into their RX from the SSG while being monitored on the TX by the Frame Error Counter. Once the PUT is placed into BIST-L loopback mode, the BIST-L Source is effectively switched out of the system in order to run the formal test.

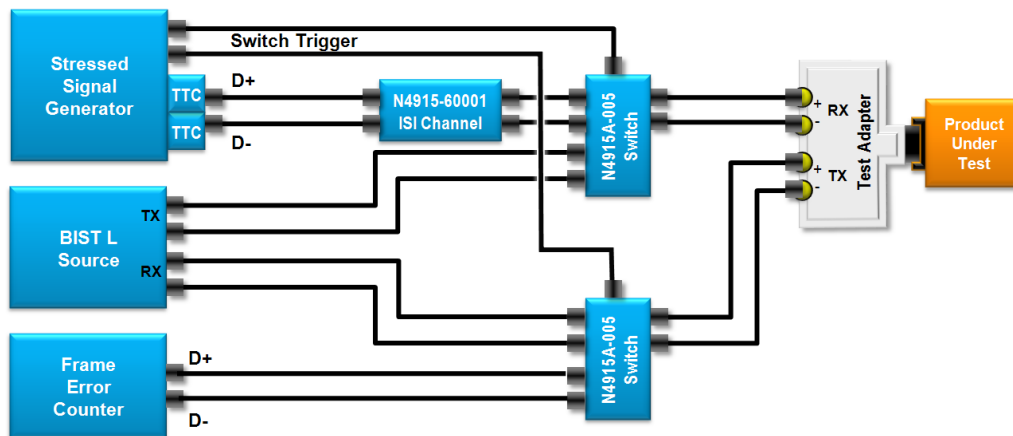

Figure A-1a: Basic RSG-01/02/03/05/06 Test Setup with separate BIST L Source

Serial ATA Logo Working Group

Figure A-1b shows a Test Setup that supports both disconnect and non-disconnect PUT's, for tests RSG-01, -02, -03, -05, and -06. The SSG acts as BIST L Source.

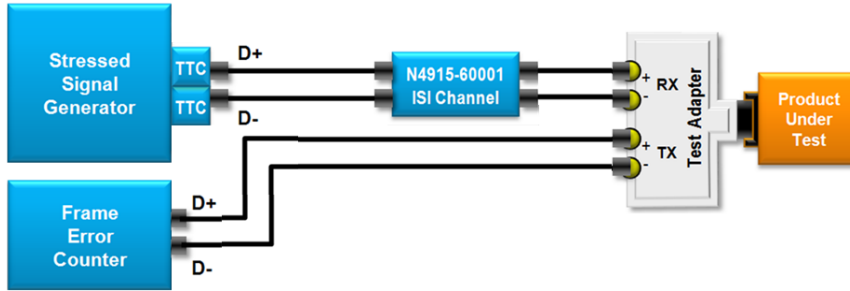

Figure A-1b: Basic RSG-01/02/03/05/06 Test Setup. SSG performs BIST L training

Note: The CIC N4915-60001 is removed from the RSG setup for gen3u host testing for 1.5Gb/s, 3Gb/s and 6Gb/s .

Figure A-2 illustrates how the Keysight 81133/4A pulse/pattern generator may be used as the SSG. If the J-BERT is used as the SSG, no additional sources are required. The setup using the 81133/4A requires two external sources to generate jitter. The outputs of the DJ and RJ modulation sources are combined through a power divider into the 81133/4A's Delay Control Input. An additional signal generator is required for testing with SSC.

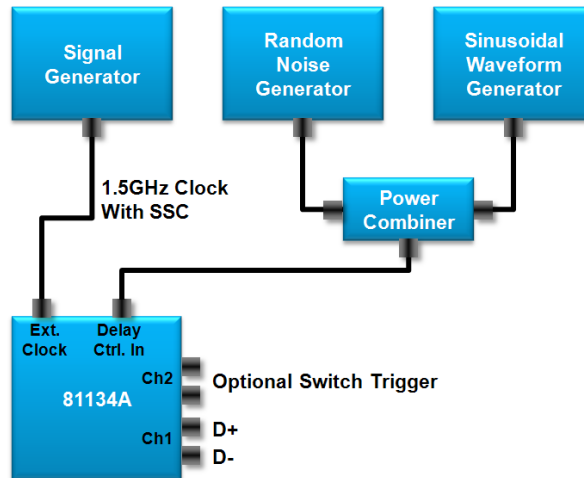

Figure A-2: Use of Keysight 81133/4A as the SSG

Serial ATA Logo Working Group

Appendix B – SSG Calibration Procedure (using Keysight DSO8xxxx/9xxxxx Real-Time DSO as the JMD)

Purpose: To define a procedure for verification and calibration of the stressed signal generator setup, using the Keysight Infiniium DS08xxxx/9xxxx as the Jitter Measurement Device.

References:

[1] Serial ATA Interoperability Program Revision 1.5 Unified Test Document, Section 2.17

Last Modification: May 2, 2013

Discussion:

Prior to running the actual stressed receiver tests, it is necessary to perform several steps to verify and calibrate the test system, in order to ensure that the signal delivered to the receiver of the PUT exhibits the proper type and amount of stress for the each test, as defined in [1].

Note that the reference planes and calibration values for many of the stressing parameters are dependent on the type of DUT (Gen1/2/3). A summary of the calibration parameters, reference planes, and measurement methods is provided in Table 15 of the UTD. Refer to the requirements of Table 15 when performing all calibrations.

The setup and calibration procedure is as follows:

B.1 - Verify Rise Time at the Reference Plane:

- Load the **LFTP** pattern into the SSG. See appendix E through H.
- Set SSG to 400mV diff
- Set up DSA for differential measurement
- Set up DSA to use CDR with constant clock
- Perform a rise time measurement on the DSO by going to **Measure->Time->Rise Time**. You should now see the rise time result at the bottom of the screen. However, note that this is the 10-90% rise time, not 20-80% as defined by SATA. To change the rise time algorithm, right click anywhere in the rise time result area, and select “**Change Thresholds...**”. Under the **Thresholds** pull down menu, select **20%,50%,80% of Top, Base**, and click **Close**. You should now see the correct 20-80% rise time value in the measurement result.

B.2 - Verify that the Skew at the Reference Plane is Less Than 10ps:

- Press **Default Setup** to reinitialize the DSO.
- Turn **Channel 3 ON** using the selector button on the front panel.
- Adjust **Channels 1 and 3** to **200mV/div** using the **Vertical** knobs on the front panel.
- Zoom in to **10ps/div**, using the **Horizontal** knob on the front panel.
- Invert the Channel 3 signal by going to **Analyze->Math**, and selecting function **f3**. Check the **Display On** checkbox, and select **Invert** as the Operator, and **Channel 3** as Source 1.
- Turn Channel 3 **OFF** using the selector button on the front panel.
- Visually compare the zero crossing times between the **Channel 1** and **Function 3** waveforms, and verify that the difference between them is less than 10ps (i.e., one horizontal division).

Serial ATA Logo Working Group

- If the skew is more than 10ps, the SMA cables from the SSG are the likely cause. Try different cables (or change one of the two in the pair) and re-measure the skew until the result is less than 10ps.

B.3 - Calibrate RJ at the Reference Plane:

To measure jitter using the DSO, we will use the **RJ DJ Setup Wizard** to set up the instrument:

- Load **MFTP** pattern into SSG
- Go to **Analyze->Jitter**, then click the **RJ DJ Setup Wizard** button.
- Click **Next**, then **Next** again.
- Set the **Source** to **Function 4**, Pattern Length to **Arbitrary**. Click **Next**.
- Click **Next** again to skip past the **Measurement Setup** screen.
- Under the **Clock Recovery** screen, set **Constant Frequency, 1.5, 3.0, or 6.0Gb/s**, and select **Semi-Automatic**, as before. Click **Next**.
- Click **Next** again to skip past the **Thresholds** screen.
- On the **Acquisition** screen, you will specify sample rate and memory depth setting (This should be **40GS/s** and **131Kpts** for **Gen1**.) Then click **Next**.
- Click **Finish** to exit the Wizard. You can also click **Close** on the Jitter window to get rid of that.

The scope should start running, and you should see the RJ/DJ screen accumulating values. Look at the **RJ(RMS, narrow)** result at the bottom of the scope screen. Adjust the RJ of the SSG until this value is **8.57ps RMS for Gen1/1m, 4.285ps RMS for Gen2/2m, and 2.14ps RMS for Gen3** (See Appendix J for suggested initial SSG settings). Record the SSG settings that produce the desired RJ value on the DSO display.

B.4 - Calibrate Sinusoidal DJ at the Reference Plane:

- With the RJ disabled, increase the DJ of the SSG until the DJ is 270mUI for Gen1 and Gen2, and 192mUI for Gen3. Record the settings that produce the desired DJ result on the DSO display.

B.5 - Calibrate TJ at the Reference Plane:

- Using the calibrated settings for RJ and DJ, measure the TJ at TP2 using the FCOMP pattern. For all test cases except for gen3u host the proper gen1 / gen2 / gen3 ISI trace of N4915-60001 CIC is used. For gen3u host the SATA CIC trace is embedded on the DSA. And verify that the value meets the requirements defined in Table 15. If the measured TJ value does not meet the Table 15 requirements, check the RJ/SJ calibrations, and re-perform if necessary.

B.6 - Calibrate amplitude at the Reference Plane:

Using the calibrated settings for RJ and DJ, measure the amplitude at TP2 using the FCOMP pattern. For all test cases except for gen3u host the proper gen1 / gen2 / gen3 ISI trace of N4915-60001 CIC is used. For gen3u host the SATA CIC trace is embedded on the DSA.

For this procedure, an eye pattern is measured on the differential SSG output with all jitter enabled. The measurement is accomplished running a histogram measurement from the .45 to .55 point on the real time eye.

Serial ATA Logo Working Group

Setup the real time eye under Analyze -> Serial data.

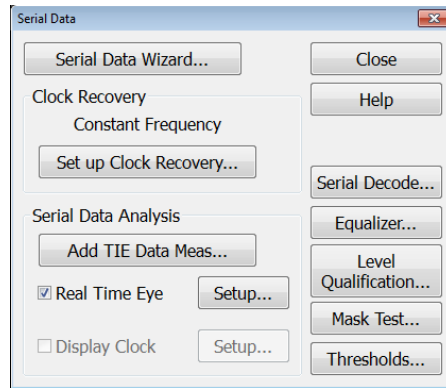

Figure B-1: Enable Real Time Eye

If a color graded view of the eye is preferred go to Setup->Display Setup and select Color Grade.

Setup the oscilloscope to capture no more and no less than 5E6 UIs. Therefore setup under Setup->Acquisition->Memory Depth the correct number of samples. Note that this is a function of the oscilloscope sampling rate and the PUT data rate. For example with 40GSamples set on the oscilloscope and testing a Gen1 product 133.5Mpoints have to be captured.

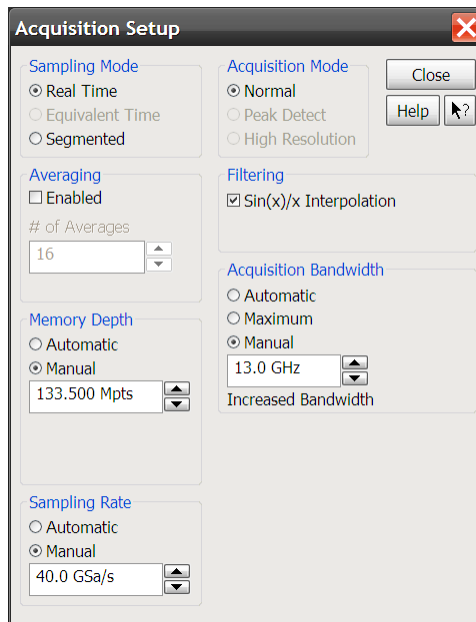

Figure B-2: Acquisition Settings for Gen1

Note with the above settings one single waveform capture of the oscilloscope will acquire 5E6 UIs. Do not accumulate multiple captures in this calibration step.

Setup the histogram measurement to measure the upper inner eye under Analyze -> Histogram between the .45 and the .55 point of the eye.

Serial ATA Logo Working Group

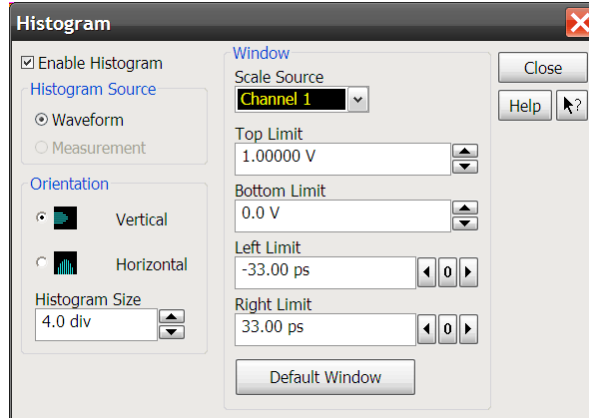

Figure B-3: Gen1 Histogram Settings for Upper Inner Eye

Read the Min value from the histogram measurement.



Figure B-4: Gen1 Histogram Example for Upper Inner Eye (not calibrated)

Setup the histogram measurement to measure the lower inner eye under Analyze -> Histogram between the .45 and the .55 point of the eye.

Serial ATA Logo Working Group

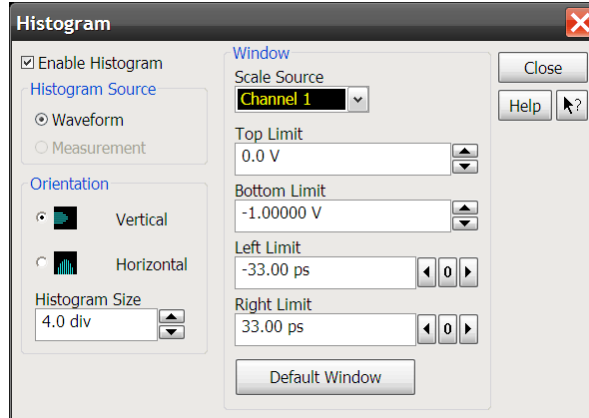

Figure B-5: Gen1 Histogram Settings for Lower Inner Eye

Read the Max value from the histogram measurement.



Figure B-6: Gen1 Histogram Example for Lower Inner Eye (not calibrated)

Calculate the inner eye height as the sum of the absolute values of the lower and upper inner eye measurements. Adjust the output voltage of the SSG to match the inner eye height with the amplitude requirement given in Table 15 “RSG

Serial ATA Logo Working Group

Setup and Calibration Steps” in the UTD document (gen1i: 325mV, gen1m: 240mV, gen2i: 275mV, gen2m: 240mV, gen3i / gen3u: 200mV for device and 240mV for host).

Serial ATA Logo Working Group

Appendix C – SSG Calibration Procedure (using Keysight N4903A/B J-BERT as the JMD) (Informative)

Purpose: To define a procedure for verification and calibration of the stressed signal generator setup, using the Keysight N4903A/B J-BERT as the Jitter Measurement Device.

References:

[1] Serial ATA Interoperability Program Revision 1.4 Unified Test Document, Section 2.17

Last Modification: February 7, 2008

Note: This appendix has not been updated for the amplitude calibration requirements in UTD 1.4.2.

Discussion:

Prior to running the actual stressed receiver tests, it is necessary to perform several steps to verify and calibrate the test system, in order to ensure that the signal delivered to the RX port of the PUT exhibits the proper type and amount of stress for the each test, as defined in [1].

First, we must verify that the SSG is providing the proper amounts of DJ and RJ at the reference plane. Note that the reference plane in this case is the end of the SMA cables, where they connect to the fixture that interfaces to the PUT.

The setup and calibration procedure is as follows:

C.1 - Configure the SSG to send a FCOMP signal:

- See Sections E.2 (for J-BERT) or F.2 (for 81134A) of this document.

C.2 - Calibrate the Differential Amplitude at the Reference Plane:

- Connect the TX+ and TX- outputs of the SSG to the positive and negative DATA IN ports of the J-BERT.
- On the J-BERT, go to **Analysis->Eye Diagram**, and press **Start** to build an eye. You should see the eye measurement results appear below the eye diagram. Read the **Eye Amplitude** value. This is the differential amplitude.
- Adjust the amplitude setting of the SSG so that the Eye Amplitude is **325mV (Gen1i)**, or **275mV (Gen2i)**, or **240mV (Gen1m/2m)**. Record the SSG settings that produce the desired amplitude at the reference plane.

C.3 - Verify a 100ps Rise Time at the Reference Plane:

- The procedure for performing the risetime verification using the J-BERT is identical to the Differential Amplitude calibration (see C.2 above). The risetime value is also reported in the results of the Eye Diagram measurement.

C.4 - Verify that the Skew at the Reference Plane is Less Than 10ps:

- *TBD - (Describe procedure using Output Timing analysis tool to compare skew of TX+ and TX- signals.)*

C.5 - Calibrate RJ to 0.180 UI at the Reference Plane:

Serial ATA Logo Working Group

(Eye Diagram method. Can also use Output Timing method, see below.)

- Go to **Analysis->Eye Diagram** on the J-BERT, and press **Start** to build an eye. You should see the eye measurement results appear below the eye diagram. Read the **Pk-Pk Jitter** value. This is the TJ, but not at the proper BER level of 1E-12. To change this, **right click** on the measurement, and select **Properties**. Under the **View** tab, in the **Calculate Measurement Results for** area, make sure **BER Threshold** is selected, and select **1E-12** from the pulldown menu. Press **OK**. Note it may take a while for the measurement to complete, but eventually you should see a TJ result for 1E-12 in the result area.

(Output Timing method. Preferred method, faster than building complete eye.)

- Go to **Analysis->Output Timing** on the J-BERT.
- (Set optimum settings under Properties.)
- Press **Start** to build a bathtub curve.

C.6 - Add Sinusoidal DJ to Create .450 UI TJ at the Reference Plane:

- With the DJ and RJ modulation enabled, repeat the **Eye Diagram TJ measurement method** described in C.5 above.

C.7 – Verification of SSG Output for Gen2 (3.0Gb/s) Rate

The setup and calibration procedure for the stressed Gen2 (3.0Gb/s) signal is identical to the procedure described above for the Gen1 signal, except that the bit rate must be set for 3.0Gb/s, and the amplitude must be set to the proper value for the given interface type (see C.2). Repeat the Gen1 procedure to determine the proper Gen2 SSG amplitude and RJ settings, as well as the DJ settings for the 5, 10, 33, and 62MHz jitter frequencies.

Serial ATA Logo Working Group

Appendix D – SSG Calibration Procedure (using Keysight 86100C DCA-J as the JMD) (Informative)

Purpose: To define a procedure for verification and calibration of the stressed signal generator setup, using the Keysight 86100C DCA-J as the Jitter Measurement Device.

References:

[1] Serial ATA Interoperability Program Revision 1.4 Unified Test Document, Section 2.17

Last Modification: February 7, 2008

Note: This appendix has not been updated for the amplitude calibration requirements in UTD 1.4.2.

Discussion:

Prior to running the actual stressed receiver tests, it is necessary to perform several steps to verify and calibrate the test system, in order to ensure that the signal delivered to the RX port of the PUT exhibits the proper type and amount of stress for the each test, as defined in [1].

First, we must verify that the SSG is providing the proper amounts of DJ and RJ at the reference plane. Note that the reference plane in this case is the end of the SMA cables, where they connect to the fixture that interfaces to the PUT.

The setup and calibration procedure is as follows:

D.1 - Configure the SSG to send an MFTP signal:

- See Sections E.2 (for J-BERT) or F.2 (for 81134A) of this document.

D.2 - Calibrate the Differential Amplitude at the Reference Plane:

- Initialize the DCA-J by pressing the **Default Setup** button. (Note this will automatically select **Oscilloscope Mode**, which is what we will use for the amplitude measurement.)
- Press the **Auto Scale** button to get an eye on the screen.
- Configure a differential trace by going to **Measure->Math**, and turn on **Function 1**. Configure Function 1 to **subtract** Channels 1 (Source 1) and 2 (Source 2). Then, turn Channel 1 **off** using the **front panel selector button** so that only Function 1 remains. Press **Auto Scale** again to optimize Function 1.
- Measure the amplitude by going to the **Amplitude** tab on the left side of the DCA-J screen, and selecting the **Vamptd** measurement. The differential amplitude value should appear at the bottom of the screen.
- Adjust the SSG amplitude (see E.3 and F.3) until the measured amplitude reads **325mVppd (Gen1i)**, or **275mV (Gen2i)**, or **240mV (Gen1m/Gen2m)**. Record the SSG amplitude setting that yields the desired output amplitude at the reference plane.

D.3 - Verify a 100ps Rise Time at the Reference Plane:

- With the DCA-J still in Oscilloscope Mode, switch to **Eye/Mask Mode** by pressing the corresponding button just to the right of the display.
- Measure the rise time by going to the **Eye Meas** tab on the left side of the screen, and selecting **More**, then the **Rise Time** measurement. The rise time value should appear at the bottom of the screen. Note that the value displayed by default is the **10-90% value**, but we want the **20-80% value** for SATA measurements. Change the measurement configuration by pressing the **Setup&Info** button on the right side of the **Measure** tab where the rise time value is displayed.

Serial ATA Logo Working Group

Select **Configure Meas...**, and select the **20%, 50%, 80%** radio button, then hit **Close**. Now, verify that the measured rise time is **100ps**.

D.4 - Verify that the Skew at the Reference Plane is Less Than 10ps:

- Reinitialize the DCA-J by pressing **Default Setup** again. Turn Channel 2 **On** using the front panel selector button. Select **Eye/Mask Mode** on the front panel, and press **Auto Scale**. You should see the two Channels' eyes appear on the display.
- Zoom in on the zero crossing area using the **Horizontal** knob. (A setting of about **10ps/div** should work well.) Turn on Marker 1 using the leftmost vertical **Marker** button on the front panel, and assign it to **Channel 1**. Assign the second vertical marker (the dashed one 3rd from the left on the front panel) to **Channel 2**. Line Marker 1 up with the Channel 1 zero crossing point, and do the same for Marker 2/Channel 2. Verify that the skew is no more than **10ps**. If the skew is excessive, try replacing one or both of your cables, and re-measuring the skew. (Note you'll probably also have to repeat the amplitude calibration also, as different cables will have slightly different losses.) See the figure below for a sample screenshot of the skew measurement.

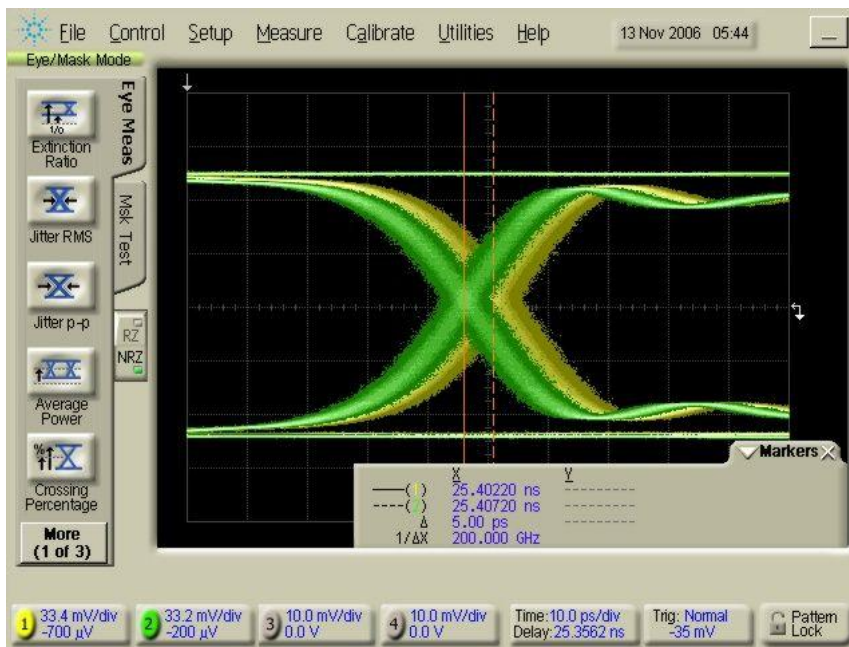

Figure D-1: Skew measurement screenshot

D.5 - Calibrate RJ to 0.180 UI at the Reference Plane:

For this procedure, we will set the initial SSG RJ to be close to the desired range, and then we will measure and fine-tune it using a jitter measurement instrument.

(Note: The first 'Jitter Mode' procedure below tends to slightly overestimate RJ (i.e., it measures more than what the J-BERT's RJ value is configured for, when using the J-BERT as the SSG.) See the alternate 'Eye/Mask mode' procedure below, which tends to better match the J-BERT's RMS RJ setting.)

Serial ATA Logo Working Group

Procedure using Jitter mode:

- Connect the positive and negative output signals from the SSG to Channels 1 and 2 of the DCA-J, respectively. Also, connect the single ended clock signal from the SSG to the **Front Panel Trigger** input of the DCA-J. Press **Default Setup** on the **DCA-J** to reinitialize the instrument.
- Configure a differential trace by going to **Measure->Math**, and turn on **Function 4**. Configure Function 4 to **subtract** Channels 1 (Source 1) and 2 (Source 2). Then, turn Channel 1 **off** using the **front panel selector button** so that only Function 4 remains. Press **Auto Scale** again to optimize Function 4.
- Enable Jitter mode by pressing the **Jitter Mode** button on the front panel. The DCA-J should auto-detect the pattern and display a jitter summary on the screen. Look at the **TJ(1E-12)** result, which should read around **140ps** or so. The **DDJ(p-p)** result should be **100fs** or less (if it isn't, your cables are skewed, or there is some other source of DJ. Check your setup.) The **RJ(rms)** value should read around **9-10 ps**.
- Change the **units** of the jitter results to **UI** by clicking on the **Setup & Info** button, selecting **Config Meas...**, and changing the **Jitter Mode Units radio button** to **Unit Interval**. Then press **Close**.
- Adjust the SSG's **RJ Amplitude** until the **TJ(1E-12)** value on the DCA-J reads **180mUI**. Record the SSG setting which results in the properly calibrated 8.57ps RMS value at the reference plane.

Alternate method using Eye/Mask mode. (Preferred method):

- Connect the positive and negative output signals from the SSG to Channels 1 and 2 of the DCA-J, respectively. Also, connect the single ended clock signal from the SSG to the **Front Panel Trigger** input of the DCA-J. Press **Default Setup** on the **DCA-J** to reinitialize the instrument.
- Configure a differential trace by going to **Measure->Math**, and turn on **Function 4**. Configure Function 4 to **subtract** Channels 1 (Source 1) and 2 (Source 2). Then, turn Channel 1 **off** using the **front panel selector button** so that only Function 4 remains. Press **Autoscale** again to optimize Function 4.
- Enable Eye/Mask mode by pressing the **Eye/Mask Mode** button on the front panel. The DCA-J should auto-detect the pattern and display the RMS measurement result on the screen, which should read around **8.0 to 8.5ps**.
- On the SSG, adjust the **RJ Amplitude** until the **Jitter RMS(f4)** value on the DCA-J reads **8.57ps**. Record the SSG setting which results in the properly calibrated 8.57ps RMS value at the reference plane.

D.6 - Add Sinusoidal DJ to Create .450 UI TJ at the Reference Plane:

Now that the RJ has been calibrated, the DJ must be added to calibrate TJ to at the specific jitter frequencies required for the test.

(Note: This is an older procedure for calibrating sinusoidal DJ, not TJ. Informative only.)

(Note: Jitter mode cannot be used here, as jitter is too large in some cases and DCA-J gives an error, saying to decrease the jitter, and/or retard the edges. Therefore Eye/Mask mode must be used instead.)

- Connect the SSG to the DCA-J, and configure **Function 4** to display the differential signal. (See first two bullets of **D.5**.)
- Turn off all jitter from the SSG output and press **Auto Scale** on the DCA-J.
- On the SSG, enable only the **DJ** component, and set to approximately **.270UI at 5MHz**. (See Appendix J for SSG initial settings.)

- Upon enabling the DJ, the DCA-J display should resemble the following:

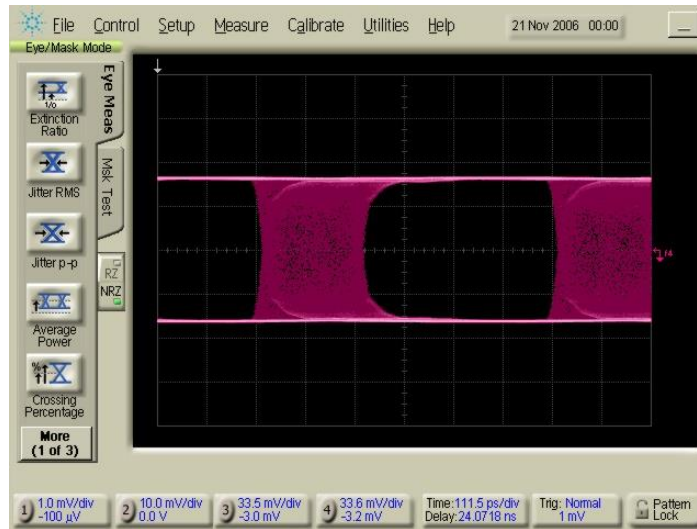

Figure D-2: DCA-J display during DJ measurement

- Now, we will set a histogram to measure the peak-to-peak width of the eye. (Note: One could also use the Jitter p-p automatic measurement shown on the left side of the DCA-J screen above, however this sometimes takes a while to converge to a stable value.) To set the histogram, go to **Measure->Histograms->Configure**. In the dialog that displays, check the **Histograms ON**, and **Show Border** checkboxes, then hit **Close**.
- Adjust the histogram by going to **Measure->Histograms->Window**, and adjusting the window boundaries to select only a thin horizontal slice of the waveform zero crossing. When finished, your display should resemble the following:

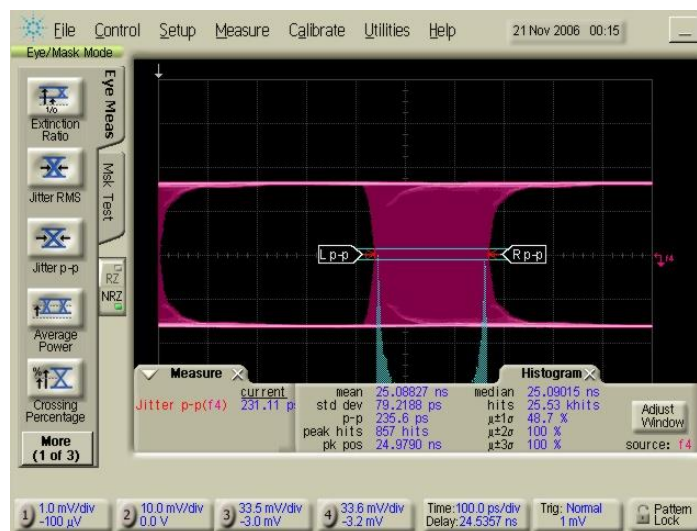

Figure D-3: Using histogram to measure pk-pk DJ

- The histogram may now be used to measure the pk-pk jitter due to the sinusoidal DJ. Adjust the J-SSG value until the DCA-J reads .270UI. Record the final SSG setting that yields the properly calibrated DJ value at the reference plane.
- Repeat the above steps for DJ frequencies of 10, 33, and 62MHz. Be sure to record the SSG settings for each frequency.

D.7 – Verification of SSG Output for Gen2 (3.0Gb/s) Rate

The setup and calibration procedure for the stressed Gen2 (3.0Gb/s) signal is identical to the procedure described above for the Gen1 signal, except that the bit rate must be set for 3.0Gb/s, and the amplitude must be set to the proper value for the given interface type (see D.2). Repeat the Gen1 procedure to determine the proper Gen2 SSG amplitude and RJ settings, as well as the DJ settings for the 5, 10, 33, and 62MHz jitter frequencies.

Serial ATA Logo Working Group

Appendix E – Using the Keysight J-BERT N4903A/B (FW v4.91 or later) as the Stressed Signal Generator (SSG)

Purpose: To document the various necessary setup and configuration procedures required when using the Keysight N4903A/B J-BERT as the Stressed Signal Generator.

References:

- [1] Serial ATA Interoperability Program Revision 1.4 Unified Test Document, Section 2.17

Last Modification: May 29, 2008

Discussion:

There are multiple suitable options available for generating the stressing signal required for performing SATA Receiver Tolerance testing. One option is to use the Keysight N4903A/B J-BERT. (*NOTE: J-BERT N4903A requires firmware v4.91 or later in order to support all jitter frequencies. For firmware update, see www.Keysight.com.*) This appendix documents the necessary procedures for setting up and configuring the J-BERT for RSG testing. (Note these procedures are referenced by other procedures in this document.)

E.1 – General SSG Setup:

Because the J-BERT is an integrated system, no external active signal generating/modulating devices are needed in order to create the stressed SATA signaling. The N4903A J-BERT is shown below:



Figure E-1: J-BERT N4903A

Note that the only external components that are needed are two Keysight 15435A Transition Time Converters (TTC's), which are needed to slow down the output rise time of the J-BERT to the required SATA levels (100ps 20/80%). These are attached directly to the DATA outputs of the J-BERT.

E.2 - Configuring the SSG to send an MFTP signal:

- (Optional): If one does not exist, you must create a new MFTP pattern file. This can be done by going to **Pattern->Pattern Editor**, then selecting the **NEW** icon. Enter “*MFTP 20 bits*” into the **Description** field, and “20” into the **Length** field. The pattern type should be **Standard**. Then, use the cursor and keyboard to edit the pattern to read “1100 1100 1100 1100 1100”. Click the **Save As** icon, and save it to file *MFTP20.ptn*.
- Load the pattern by going to **Pattern->Pattern Select**, and select the **User Pattern from File** radio button, and click the **Browse** button. Select the *MFTP20.ptn* pattern and press **OK**. Also, make

Serial ATA Logo Working Group

sure the “**Error Detector Pattern tracks the Pattern Generator Pattern**” box is checked, then press **OK**.

- Configure the initial J-BERT data amplitude by going to **PG Setup->PG Output Setup**, and entering a **0mV** value for **Vof**, and **375mV** for **Vampt**. For the Clock output, enter **0mV** for **Vof**, and **500mV** for **Vampt**.
- Next, we will set the J-BERT bit rate, by going to **PG Setup->Bit Rate Setup**. Make sure **Clock Source** is set to **Internal**, **Sub Rate Clock Divider** is **2**, and enter **1.5Gb/s** for the rate. (If you haven't already done so, add a preset for this rate by selecting the **Add Preset** button on the right.)
- Turn on the J-BERT transmitter by pressing the **Data** button on the front panel (below the display).

E.3 – Adjusting the Output Amplitude

- To adjust the output amplitude, go to **PG Setup->PG Output Setup**, adjust the **Vampt** value until the measured amplitude reads the desired value, as shown below.

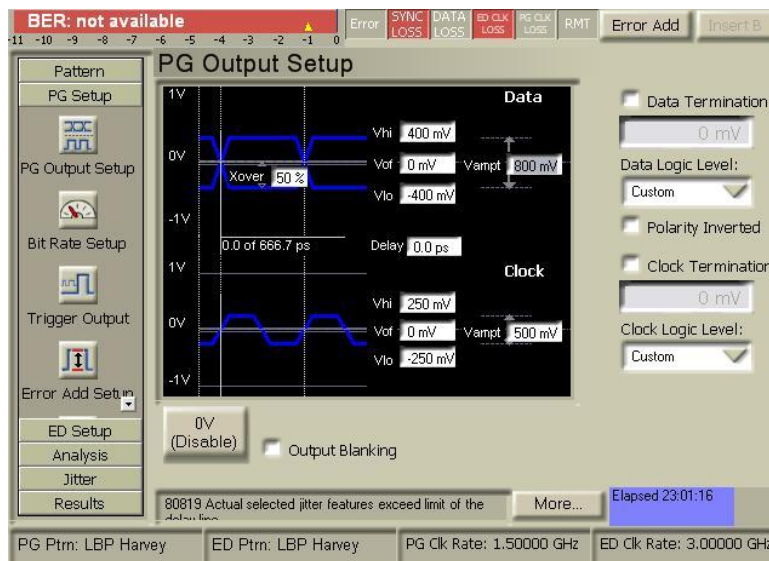

Figure E-2: J-BERT N4903A Amplitude Setup Screen

E.4 – Adjusting the Random Jitter (RJ)

- To set the initial RJ output value of the J-BERT, go to **Jitter->Jitter Setup**. Start by selecting the master jitter **Enable** checkbox in the upper left corner of the screen. Select the **200ps delay line**, and check only the purple **Random** checkbox. Under the Random settings, specify **12.8 mUI** for the **Amplitude (rms)** value. Make sure that the **10MHz high-pass** and **500MHz low-pass** filters are **OFF**. The p-p Amplitude value should read **179.2mUI**. Note that this is just below the desired output value of 180mUI.

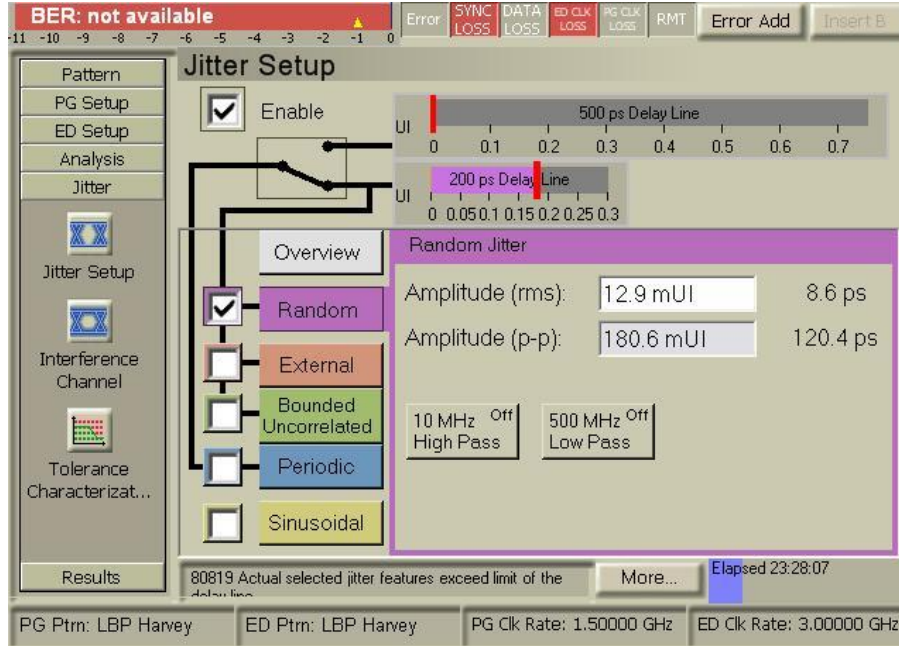

Figure E-3: J-BERT N4903A Jitter Setup Screen (RJ)

E.5 – Adjusting the Deterministic Jitter (DJ)

- To adjust the Deterministic Jitter on the J-BERT, go to **Jitter->Jitter Setup** as shown below, and adjust the **Amplitude** and **Frequency** values as desired.

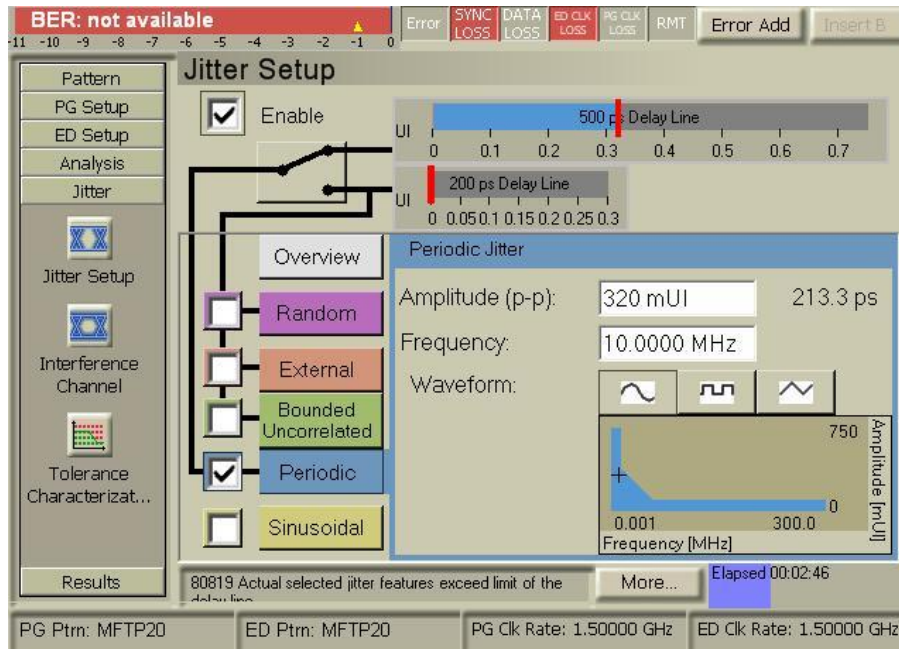

Figure E-4: J-BERT N4903A Jitter Setup Screen (DJ)

Serial ATA Logo Working Group

Appendix F - Using the Keysight J-BERT M8020A as the Stressed Signal Generator (SSG)

Purpose: To document the various necessary setup and configuration procedures required when using the Keysight J-BERT M8020A as the Stressed Signal Generator.

References:

[2] Serial ATA Interoperability Program Revision 1.4 Unified Test Document, Section 2.17

Last Modification: May 29, 2008

Discussion:

There are multiple suitable options available for generating the stressing signal required for performing SATA Receiver Tolerance testing. One option is to use the Keysight J-BERT M8020A. This appendix documents the necessary procedures for setting up and configuring the J-BERT M8020A for RSG testing. (Note these procedures are referenced by other procedures in this document.)

F.1 – General SSG Setup:

Because the J-BERT is an integrated system, no external active signal generating/modulating devices are needed in order to create the stressed SATA signaling. The J-BERT M8020A is shown below:

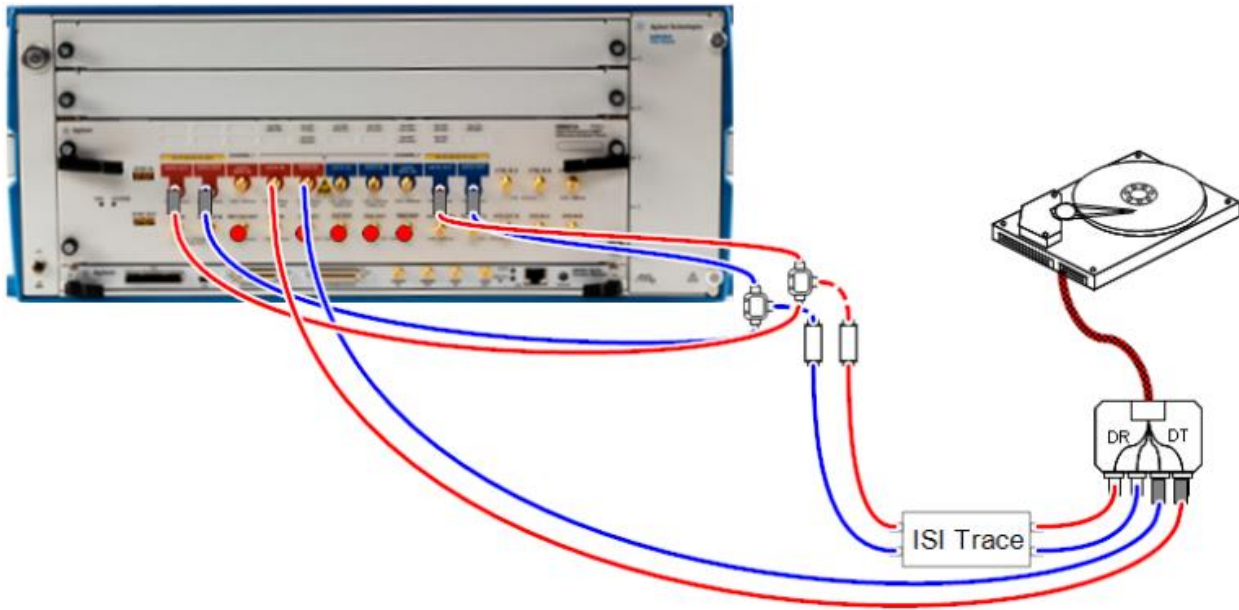

Figure F-1: J-BERT M8020A based SATA RSG test setup

Note The test setup uses an external channel add of two data channels of the J-BERT M8020A. DC blocks are required on each data output before the channel add. Transition Time Converters (TTC's), which are needed to slow down the output rise time of the J-BERT to the required SATA levels. These are attached to the power dividers used for power coupling of the two data outputs.

F.2 - Configuring the SSG to send an MFTP signal:

- Load the respective SATA application setting by going to **application->Serial ATA**
- Load the MFTP pattern by going to **Pattern-> Select Pattern -> Select Memory Pattern**, Select the **MFTP_b8b10** pattern from the **Factory -> SATA** directory. Execute **Create Sequence**.

Serial ATA Logo Working Group

- Configure the initial J-BERT data amplitude by going to **System->System View->Data Out1 Setup**, and entering a **0mV** value for **Vof**, and **375mV** for **Vampt** in the **amplifier** section. For the Clock output switch to **CLK Out**, enter **0mV** for **Vof**, and **500mV** for **Vampt** in the **amplifier** section.
- Turn on the J-BERT transmitter

F.3 – Adjusting the Output Amplitude

- To adjust the output amplitude, go to **PG Setup->PG Output Setup**, adjust the **Vampt** value until the measured amplitude reads the desired value, as shown below.

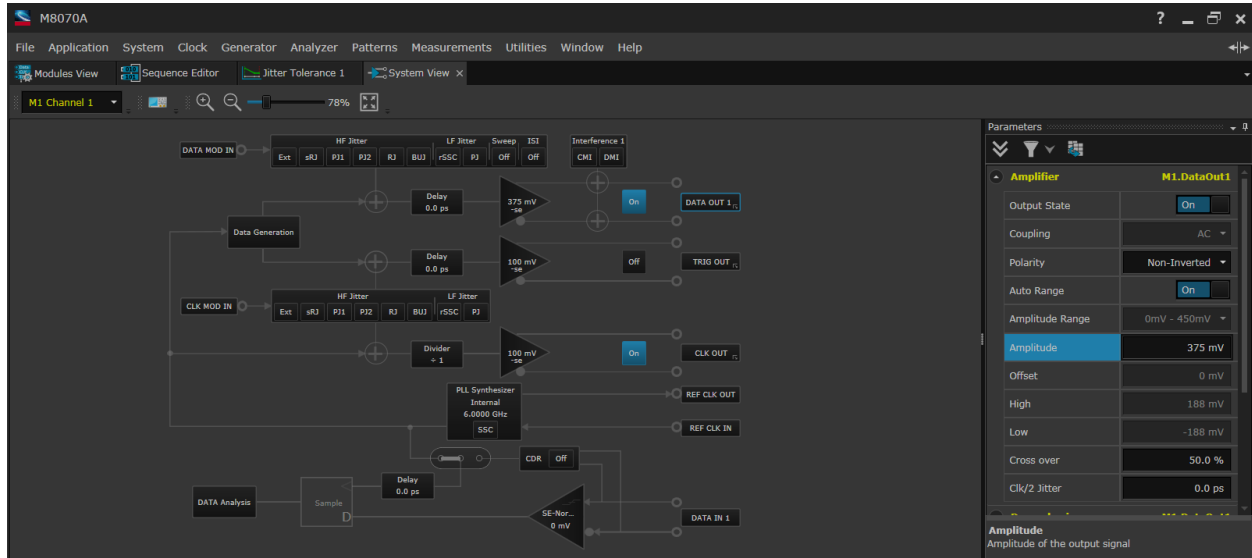

Figure F-2: J-BERT M8020A Data Out1 Amplifier Setup Screen

F.4 – Adjusting the Random Jitter (RJ)

- To set the initial RJ output value of the J-BERT, go to **Jitter Setup**. Select the **HF-Jitter**. Under the Random Jitter settings, specify **12.8 mUI** for the **Amplitude (rms)** value. Make sure that the **high-pass** filter is turned **OFF** and **low-pass** filter is set to the highest frequency. The p-p Amplitude value should read **179.2mUI**. Note that this is just below the desired output value of 180mUI.

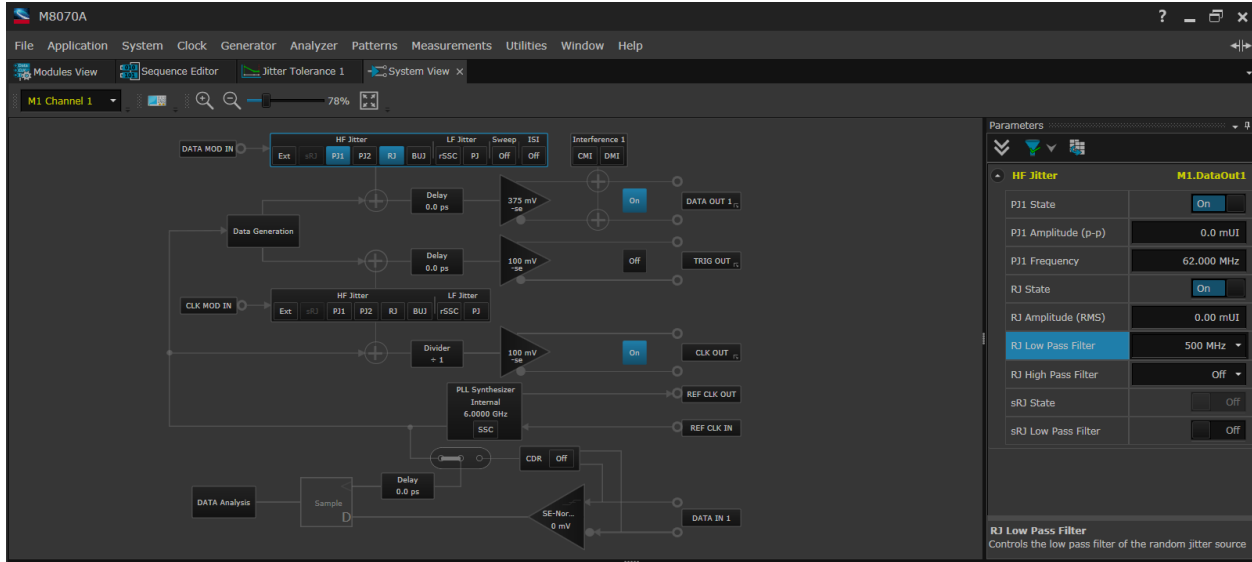

Figure F-3: J-BERT M8020A HF Jitter Setup Screen

F.5 – Adjusting the Deterministic Jitter (DJ)

- To adjust the Deterministic Jitter on the J-BERT, go to **Jitter Setup** as shown above, and adjust the **PJ1 Amplitude** and **PJ1 Frequency** values as desired.

Serial ATA Logo Working Group

Appendix G – Using the Keysight 81133/4A Pulse/Pattern Generator as the Stressed Signal Generator (SSG)

Purpose: To document the various necessary setup and configuration procedures required when using the Keysight 81133A or 81134A-based system as the Stressed Signal Generator.

References:

[1] Serial ATA Interoperability Program Revision 1.4 Unified Test Document, Section 2.17

Last Modification: February 7, 2008

Discussion:

There are multiple suitable options available for generating the stressing signal required for performing SATA Receiver Tolerance testing. One option is to use a system built around the Keysight 81133/4A Pulse/Pattern Generator. This appendix documents the necessary procedures for setting up and configuring the system for RSG testing. (Note these procedures are referenced by other procedures in this document.)

G.1 – General SSG Setup:

The general setup using the 81134A and associated components is shown below:

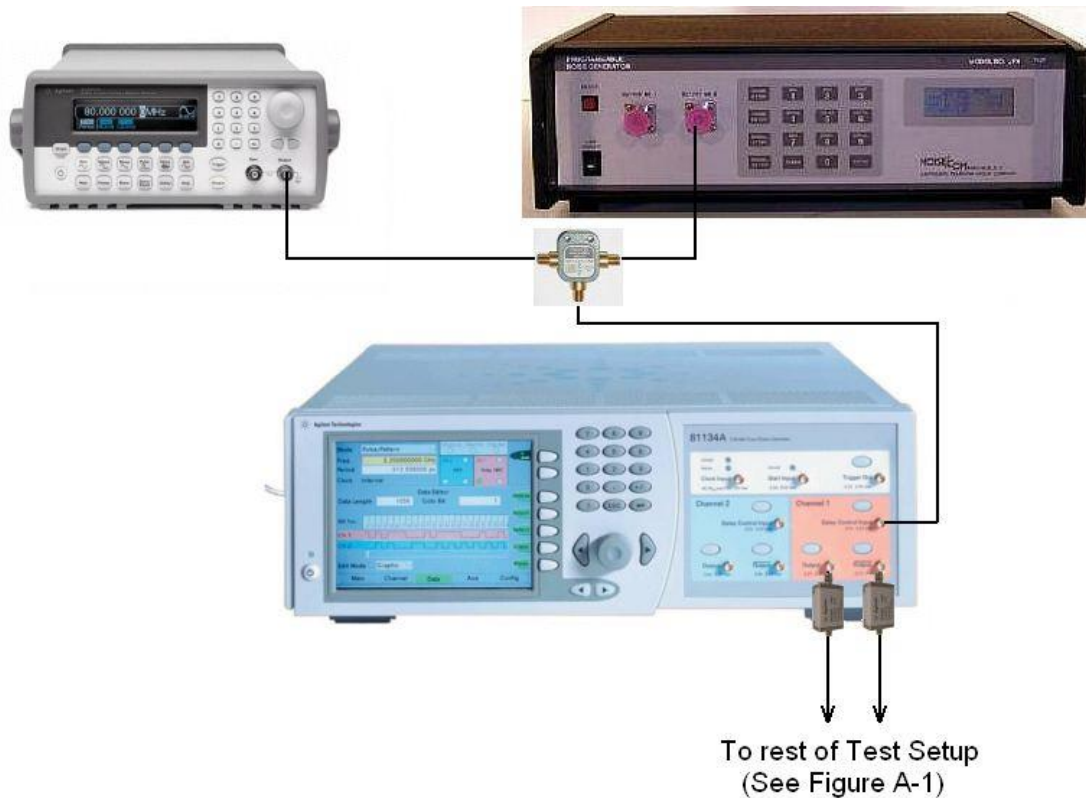

Figure G-1: Keysight 81134A Pulse and Pattern Generator, Keysight 33250A Function/Arbitrary Waveform Generator, and Noisecom PNG-7110 Noise Generator

Note the use of the Keysight 15435A Transition Time Converters on the output of the 81134A. The Transition Time Converters are needed to slow the rise time of the 81134A's output to 100ps (20/80%).

G.2 - Configuring the SSG to send an MFTP or FCOMP signal:

- To create an **MFTP** pattern. Go to the **Data** tab. Enter a pattern length of 32 bits. Edit the pattern to read “1100 1100 1100 1100 1100 1100 1100 1100”.
- To create **FCOMP**: Use Keysight Pattern Loading Tool to upload pattern file to 81134A.
- Configure the initial data amplitude by going to the **Channel** tab, and under Channel 1 (orange screen) enter an **Offset of 0mV**, and Amplitude of **405/375mV (Gen1i/2i)**, or **270/310mV (Gen1m/2m)**. Additionally select **Data, Normal**, and **NRZ** under the Channel 1 settings. Select the delay control input to **250ps**. Levels **Normal**.
- Select **Pulse/Pattern Mode** in the upper part of the display and select the required frequency. Enter **1.500000000GHz** for RSG-01 and **3.000000000GHz** for RSG-02.
- Turn on the transmitter by pressing the two Output buttons for the differential signal on the front panel.
- Under the **AUX** screen of the **81134A**, set all values as shown in Figure G-2, below.

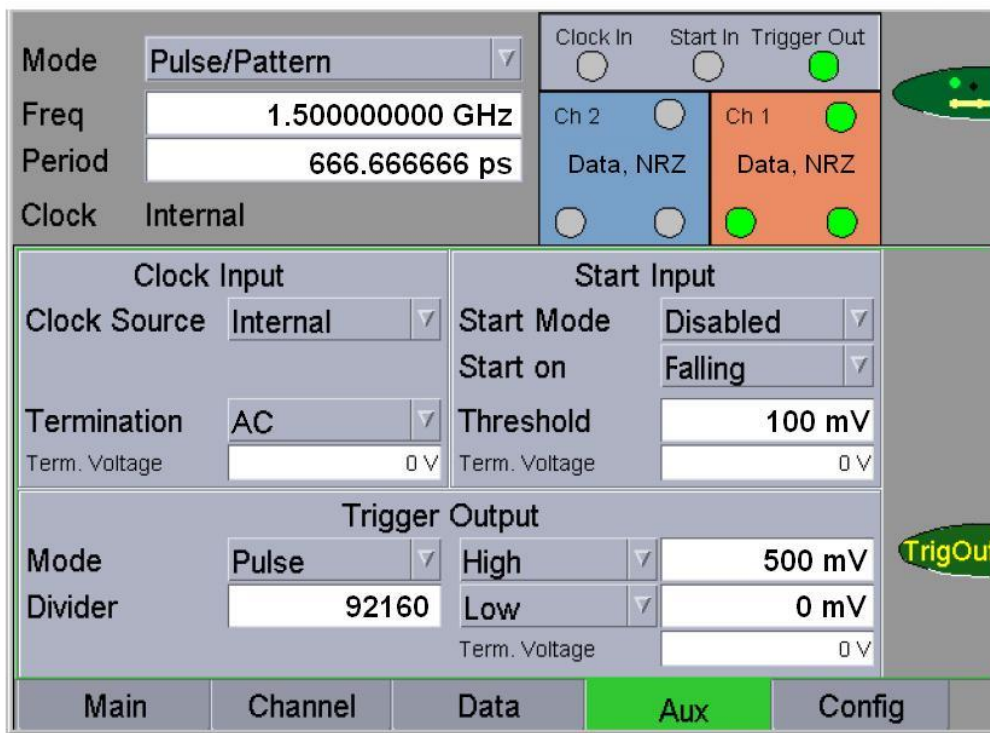

Figure F-2: 81134A Aux Screen Showing Proper Test Settings

G.3 – Adjusting the Output Amplitude

- To adjust the output amplitude on the 81134A, go to the **Channel** tab, and under the settings for **Channel 1** (the orange screen), enter the amplitude value under the **Ampl** field.

G.4 – Adjusting the Random Jitter (RJ)

- To adjust the RJ, simply increase/decrease the output of the **Noisecom PNG-7110 Programmable Noise Generator** by pressing the **NOISE ATTEN** button, entering a numeric value using the keypad, then pressing **ENTER**.
- (Note that it is also possible, after pressing **ENTER**, to simply press the **1 (INC)**, and **2 (DEC)** buttons to increment and decrement the noise amplitude by fractional steps.)

G.5 – Adjusting the Deterministic Jitter (DJ)

- To adjust the Deterministic Jitter via the **33250A Function/Arbitrary Waveform Generator**, turn on the output in pressing the **Output** button at the front panel. Select a sinusoidal waveform by pressing the **Sine** button at the front panel. Use the **Frequency** hotkey to set the required frequency. Calibrate the deterministic jitter by adjusting the Amplitude and observing the jitter reading on the JMD.

Serial ATA Logo Working Group

Appendix H – Using the Keysight N4219B Serial ATA Probe as the Frame Error Detector

Purpose: To define a procedure for initial setup, configuration, and verification of the SATA Probe, for the purpose of being used as the Frame Error Detector.

References:

- [1] Serial ATA Interoperability Program Revision 1.4 Unified Test Document, Section 2.17

Last Modification: November 13, 2006

Discussion:

Prior to running the actual stressed receiver tests, it is necessary to perform several steps to configure and verify proper operation of the Frame Error Detector. One possible implementation of a Frame Error Detector utilizes the Keysight N4219B SATA Probe in conjunction with an appropriate Logic Analyzer.

H.1 – Probe Setup and Configuration

1. Connect the N4219B Serial ATA probe to the logic analyzer according to the installation instructions.



2. Make sure that POD 1, 2 and POD 3, 4 for Port 1 are connected to the logic analyzer. A connection for Port 2 is not required for this test.
3. Power up the N4219B and the logic analyzer and start from the default settings. The following screen shot shows a typical start-up screen.

Serial ATA Logo Working Group

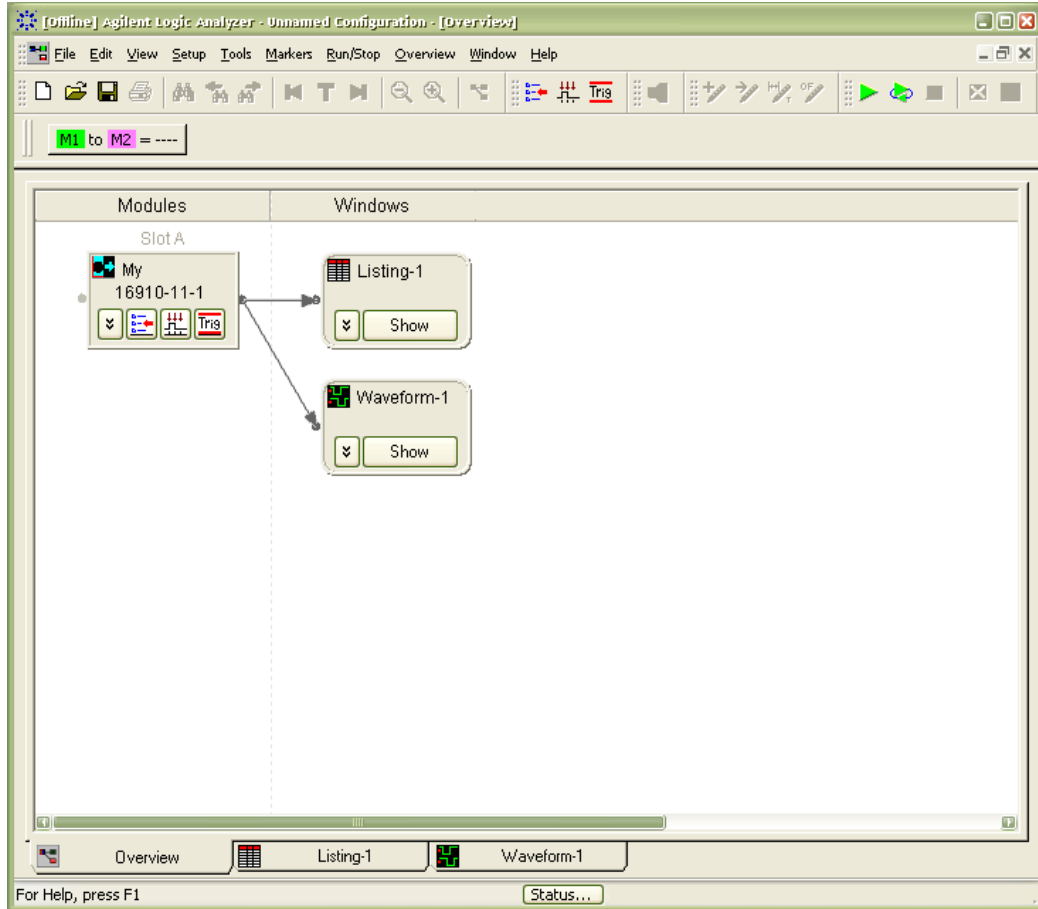

4. Select File-> Open and browse to the N4219B default configurations:

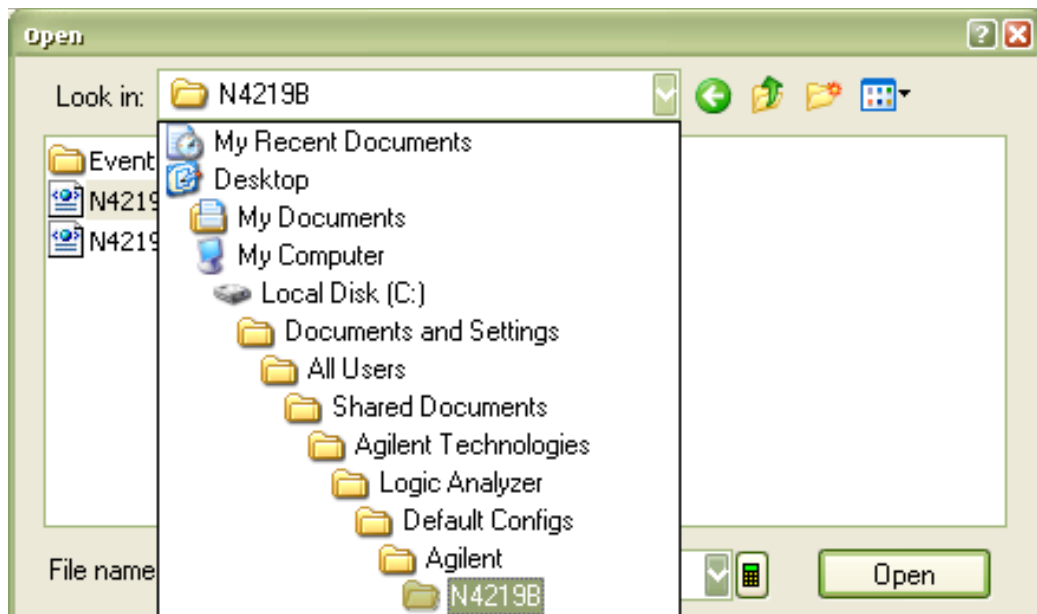

5. Select the N4219B_1.xml file and open it:

Serial ATA Logo Working Group

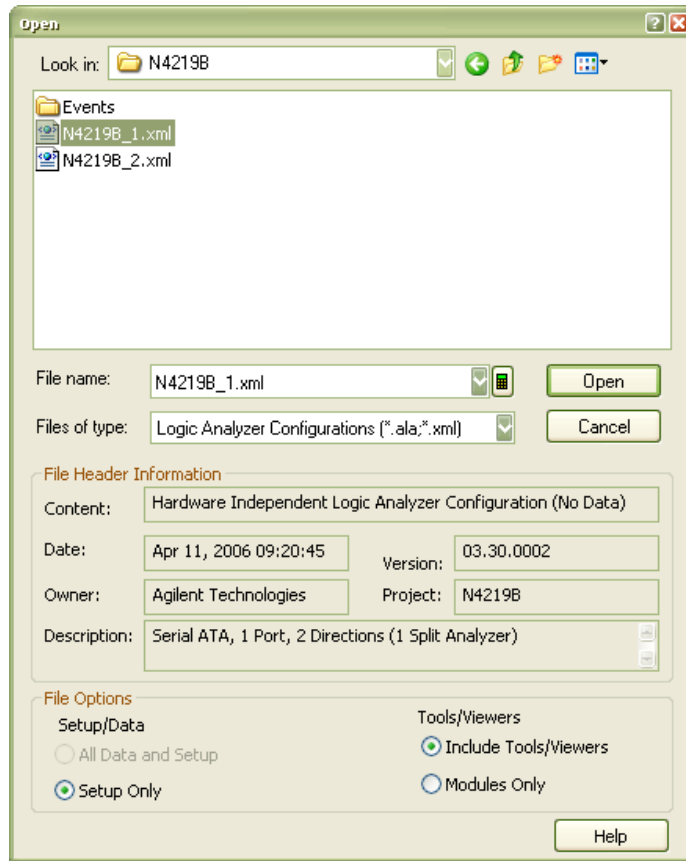

6. The logic analyzer will open a number of tabs and show the following default configuration:

Serial ATA Logo Working Group

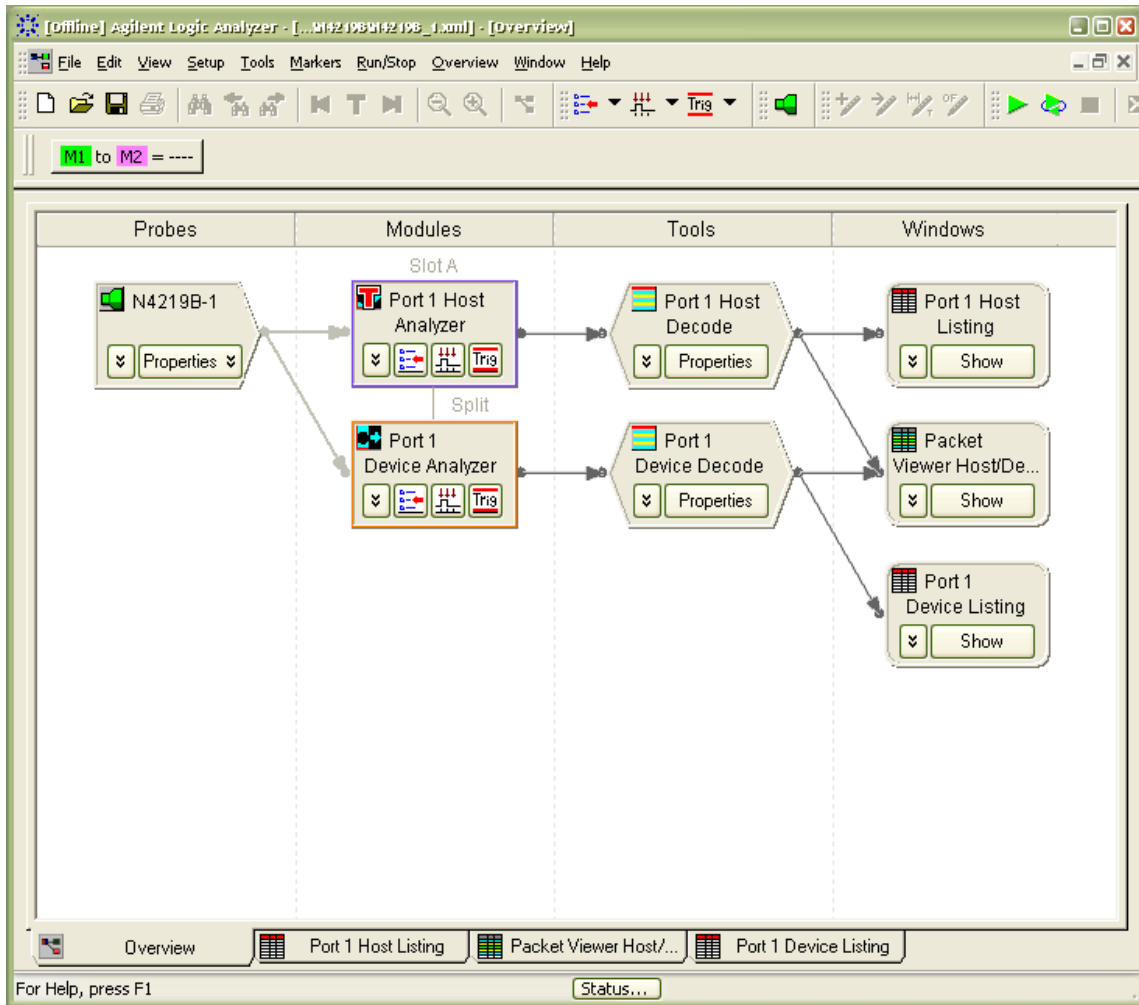

The Overview tab gives access to all required features for this test. For setup the N4219B Properties and the Port1 Device Analyzer Trigger will be configured later. When running the FER test the Status button at the bottom of this window will lead to the test results.

7. Make sure your PUT is transmitter output is connected to Port 1 HR/DT:



The HT/DR of Port 1 and Port 2 won't be connected for this test.

Serial ATA Logo Working Group

- Open the N4219B Properties Setup from the Overview tab of the logic analyzer. Make sure your settings are as shown below.
Set the Port 1 Probe Rate according to your test speed requirements. For RSG-01 this is 1.5Gbps and for RSG-02 this is 3Gbps. Once the PUT is transmitting the Port 1 Device Status will show the link status and speed.
The definition of Primitive Recognizers or Events is not required for this test.

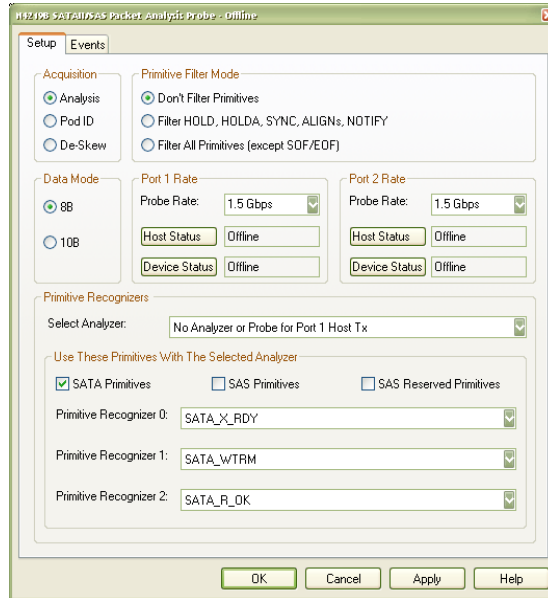

- Open the Port 1 Device Analyzer Trigger menu and define the trigger as illustrated below:

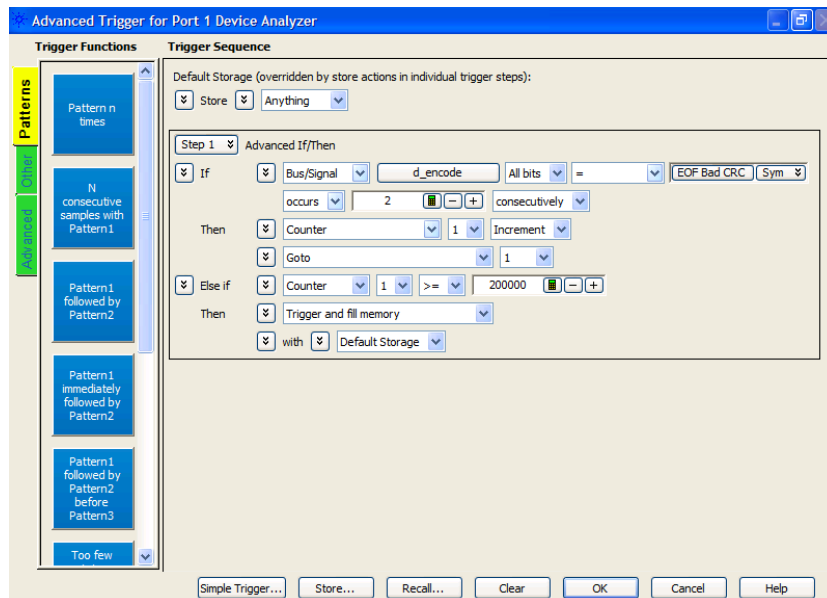

The underlying idea of this trigger definition is to use one of the logic analyzer's internal real-time counters to count frames with wrong checksum (EOF Bad CRC). Based on the N4219B design this event will occur twice for each frame. To count the number of events correctly it is important to know that EOF Bad CRC will occur 2 times in a consecutive manner for 1 wrong frame.

The "else if" part of the trigger is not required for this test but avoids a warning message that indicates a trigger

Serial ATA Logo Working Group

with no exit path.

10. Before starting the logic analyzer for FER test open the Status window from the main overview:

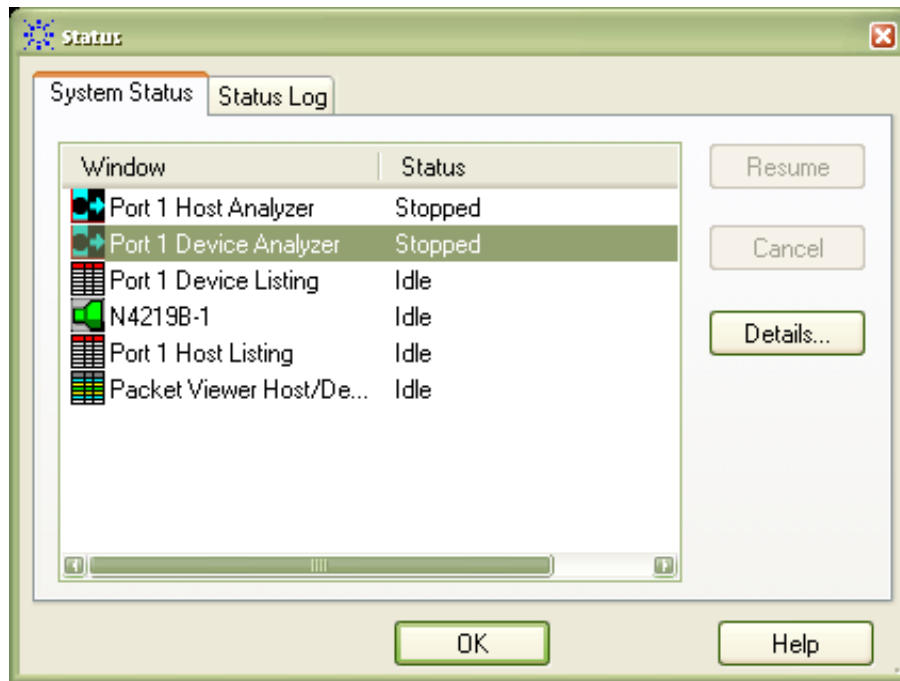

11. Open the Details for Port 1 Device Analyzer:

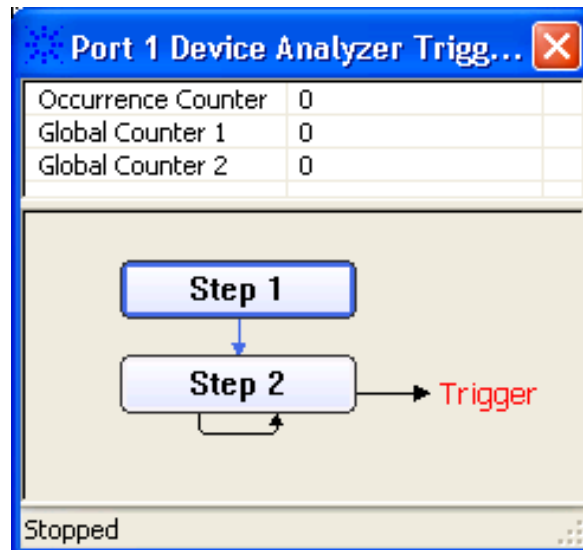

The Global Counter 1 values gives the actual number of FER errors in real-time while running the test. Based on the pass/fail criteria for RSG-01 and RSG-02 the test may be interrupted if the number of FERs reached its limit.

The counter resets each time the logic analyzer is started. Thus stop and start the logic analyzer once the setup is ready for the FER test.

Serial ATA Logo Working Group

Appendix I – Using the Crescent Heart Software SATA-II Probe as the Frame Error Detector

Purpose: To provide a procedure for using the Crescent Heart Software SATA-II Analyzer Probe as an alternate Frame Error Detector.

References: None

Last Modification: April 28, 2007

Discussion:

Appendix H of this MOI defines a procedure for using the Keysight N4219B Serial ATA Probe and associated Logic Analyzer as a Frame Error Detector. An alternative to this Frame Error Detector implementation is the Crescent Heart Software SATA-II Probe Adapter, which provides a simple means for monitoring and counting a variety of SATA error conditions, in addition to CRC-errored frames.

Note that a complete user’s manual for the SATA-II Probe can be obtained from the Crescent Heart Website, as well as an abbreviated manual for using the SATA-II probe for Frame Error Detection purposes. (See <http://www.c-h-s.com/SATA.shtml>) The following instructions provide a general procedure, but refer to the formal product documentation if additional detail is desired.

After installing the Application software on a standard USB-equipped PC, and launching the application, you should see the following screen:

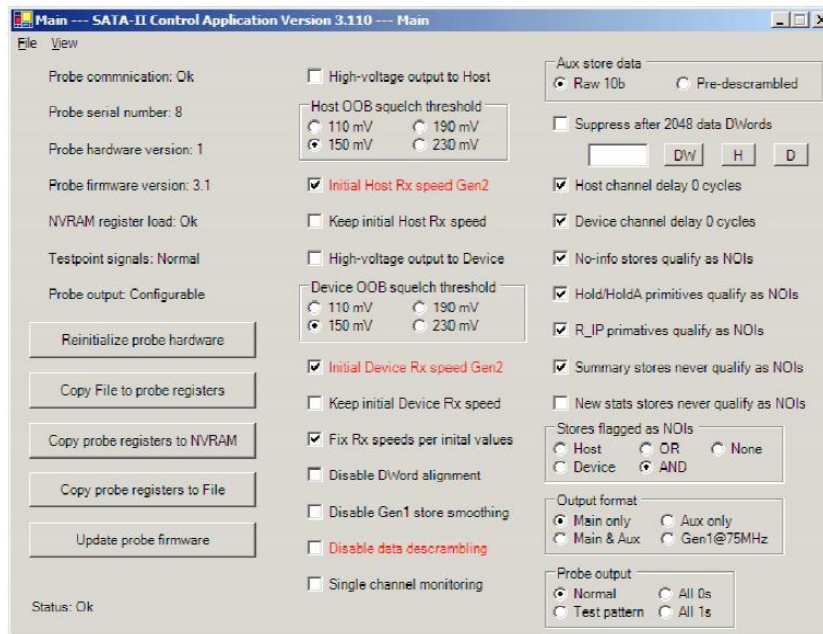

Figure I-1: SATA-II Control Application Main Window

Configure the settings as shown in Figure H-1 above (making note to properly de-select the ‘Initial Host RX speed Gen2’, and ‘Initial Device RX speed Gen2’ boxes if Gen1 PUT testing is being performed.)

Once the Main Window settings are configured, go to **View->Counters** to select the Counters window, shown in Figure H-2, below:

Serial ATA Logo Working Group

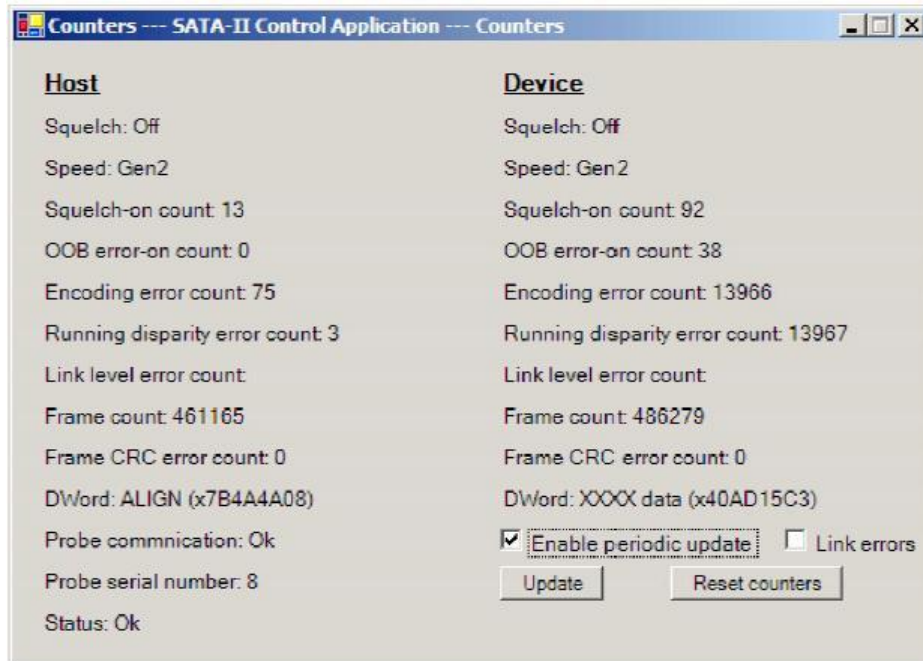

Figure I-2: Counters Window

The **Frame Count** and **Frame CRC Error Count** values are the most pertinent to the RSG test procedure. Making sure the **Enable Periodic Update** box is checked, the **Frame Count** value should increment when the probe is connected and functioning properly. Note that it is generally beneficial in every test setup to verify that the **Frame CRC Error Count** counter is also functioning properly by loading an intentionally CRC-errored frame pattern into the SSG and sending it through the loopback-enabled PUT. In this case the CRC Error counter should increment for every received frame.

Note that for RSG testing, it is normal for the **Link Level Error Count** counter to increment during testing. This is simply due to the fact that the normal Link Level protocol is not being obeyed by the PUT during the RSG test, and thus this counter may be ignored.

Also note that in some cases it may be observed that the other error counters may increment during a test. Although relatively uncommon, it is possible for Running Disparity or Encoding Errors to occur on the wire that will be detected as errors by the probe, but NOT cause a CRC error to occur. This is due to the fact that these errors sometimes occur OUTSIDE of the SATA frame (i.e., the contents covered by the CRC). Because the SATA RSG test is defined as a **frame error** test (rather than a **bit error** test), these types of errors occurring outside of the CRC-applicable frame are not counted as observed errors, and therefore do not affect the pass/fail criteria for a given PUT. (However it is recommended that if such errors are observed during testing, some effort be made to determine the cause, as such errors should not typically occur for devices operating with a significant degree of receiver margin.)

Serial ATA Logo Working Group

Appendix J – Suggested Initial Amplitude and DJ/RJ Settings for Various SSG Setups (Obsolete)

Purpose: To provide a table of initial (i.e., pre-calibrated) amplitude, DJ, and RJ, settings for various SSG’s.

References: None

Last Modification: June 7, 2007

Discussion:

In this MOI, two types of SSG sources are defined (J-BERT vs. 81134A with external modulation source). (Note that both of these setups assume the use of Transition Time Converters (TTC’s), and 50/50 power splitters on their outputs. Note that the 50/50 power splitters add approximately 6dB of flat loss to the signal path.) This appendix contains suggested starting values for initializing the amplitude, RJ, and DJ settings prior to performing the calibration steps of Appendices B, C, and D. These are informative values intended as initial starting points when performing the calibration procedure.

	81134A+33250A as SSG	81134A+E4432B as SSG	J-BERT as SSG
Gen1:			
Ampl (162.5/325mV)	405mV**	405mV**	(TBD)
RJ (8.57ps RMS)	18.00	18.00	(TBD)
DJ (10MHz)	770mVpp	280mV	(TBD)
DJ (33MHz)	630mVpp	250mV	N/A
DJ (62MHz)	810mVpp	260mV	N/A
Gen2			
Ampl (137.5/275mV)	375mV**	375mV**	(TBD)
RJ (4.285ps RMS)	23.00	23.00	(TBD)
DJ (10MHz)	370mVpp	125mV	(TBD)
DJ (33MHz)	350mVpp	115mV	(TBD)
DJ (62MHz)	370mVpp	120mV	(TBD)

**For Gen1m/2m amplitude levels (informative):
 Gen1m: Use 270mV to get 120/240mV at 1.5G
 Gen2m: Use 310mV to get 120/240mV at 3.0G

Table J-1: Suggested Initial Settings for Various Equipment Setups

Serial ATA Logo Working Group

Appendix K – Using the Keysight N5990A Test Automation Software Option 103 (a.k.a. Valiframe)

Purpose: To document the use of the N5990A Test Automation Software Option 103 for RSG-01 and RSG-02 tests. (N5990A is also referred to as ‘Valiframe’.)

References: None

Last Modification: June 05, 2007

Discussion:

The Keysight N5990A-103 test automation software automates all manual steps listed under RSG-01 and RSG-02 in this document. All calibrations and measurements follow the same proceedings.

K.1 – General Setup:

The Setup consists of following components:

- Keysight 81134A as SSG
- Keysight 33250A or Keysight ESG (model number) as sine source for generating sinusoidal jitter
- NoiseCom noise source as listed above for generating random jitter.
- Keysight DSO80000 series oscilloscope as JMD
- Keysight 16800 series or 16900 series Logic Analyzer + N4219BA as Frame Error Detector
- PC with Windows XP and N5990A Option 130 Software as Host PC

Alternatively the following instruments are also supported:

- Crescent Heart Software SATA Probe as Frame Error Detector.
- Keysight JBERT

The cabling is identical to the setup for the manual test procedure described before in this document. The following diagram shows how to connect the instruments to the host PC.

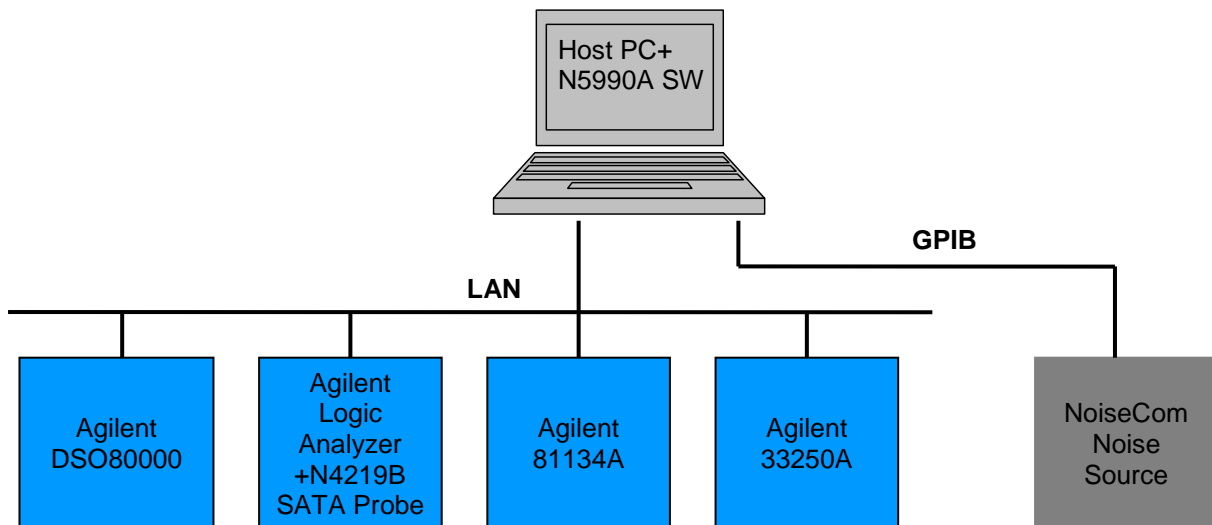

Figure K-1: Test Equipment Network Diagram

K.2 – Installing and Configuring the Software:

Before installing the Keysight N5990A Test Automation Software Option 103 the following components should be installed on the Host PC:

- Microsoft .NET Framework 1.1

Serial ATA Logo Working Group

- Microsoft .NET Framework 2.0
 - Microsoft Excel 2003 or higher
 - Keysight IO Libraries Suite 14.2
 - Keysight T&M Programmers Toolkit Redistributable Package 1.1
- On the Keysight 16900A Logic Analyzer this software must be installed:
- VFAg1600AServer

After installing Valiframe “Valiframe Station Configuration” should be called once the setup the different addresses of the instruments:

- Start Valiframe Station Configuration

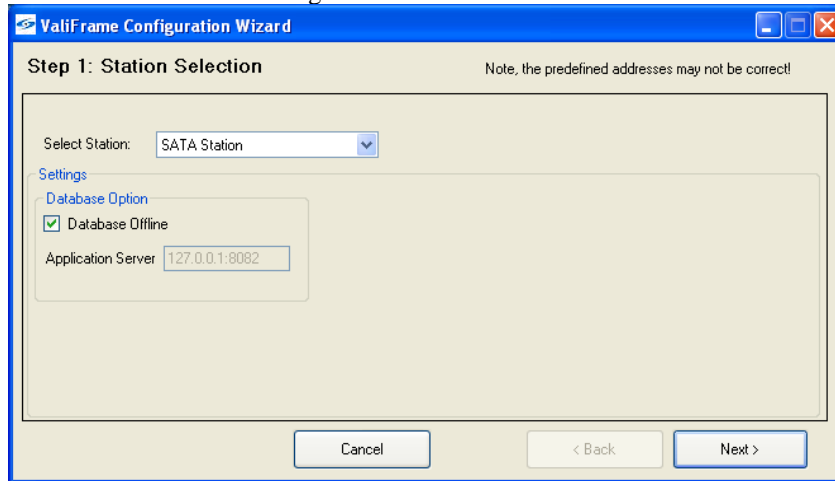

Press “Next”.

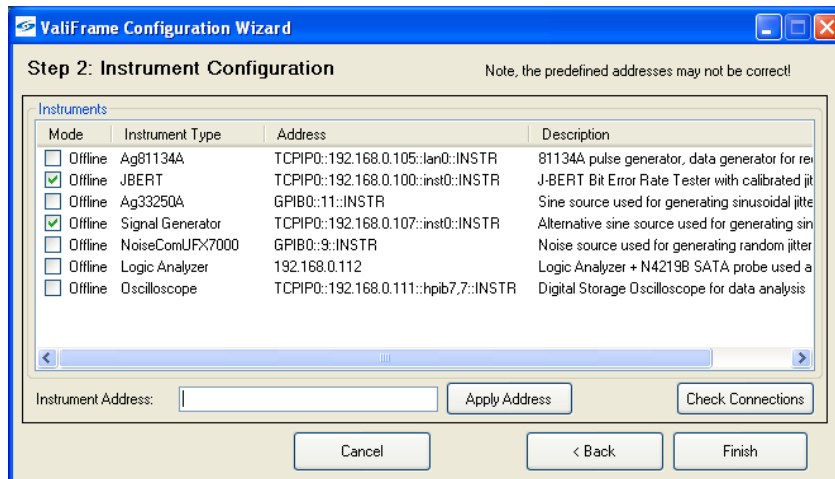

Offline Flags of J-BERT and Signal Generator should be checked. Offline flags for all other instruments should be unchecked. The addresses of the instruments must be changed. Press “Finish”.

K.2 – Test RSG-02: Gen2 (3.0Gb/s) Receiver Jitter Tolerance Test

- Start Valiframe.

Serial ATA Logo Working Group

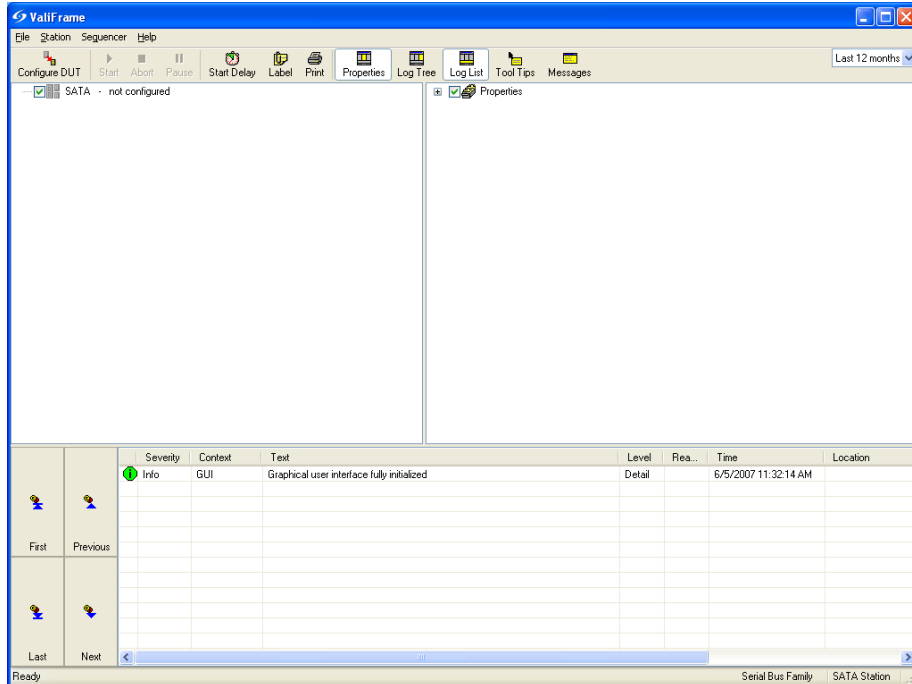

- Press "Configure".

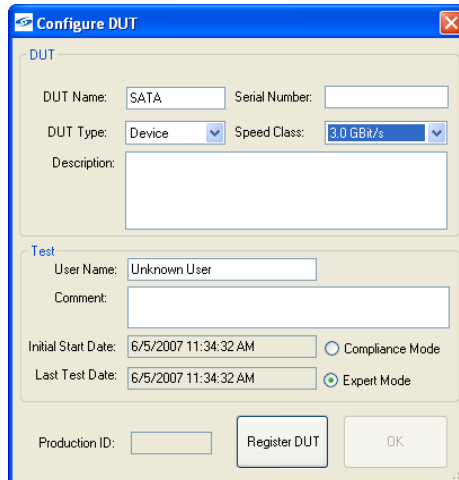

- Select Speed Class 3.0 GBit/s and press Register DUT and then OK.

Serial ATA Logo Working Group

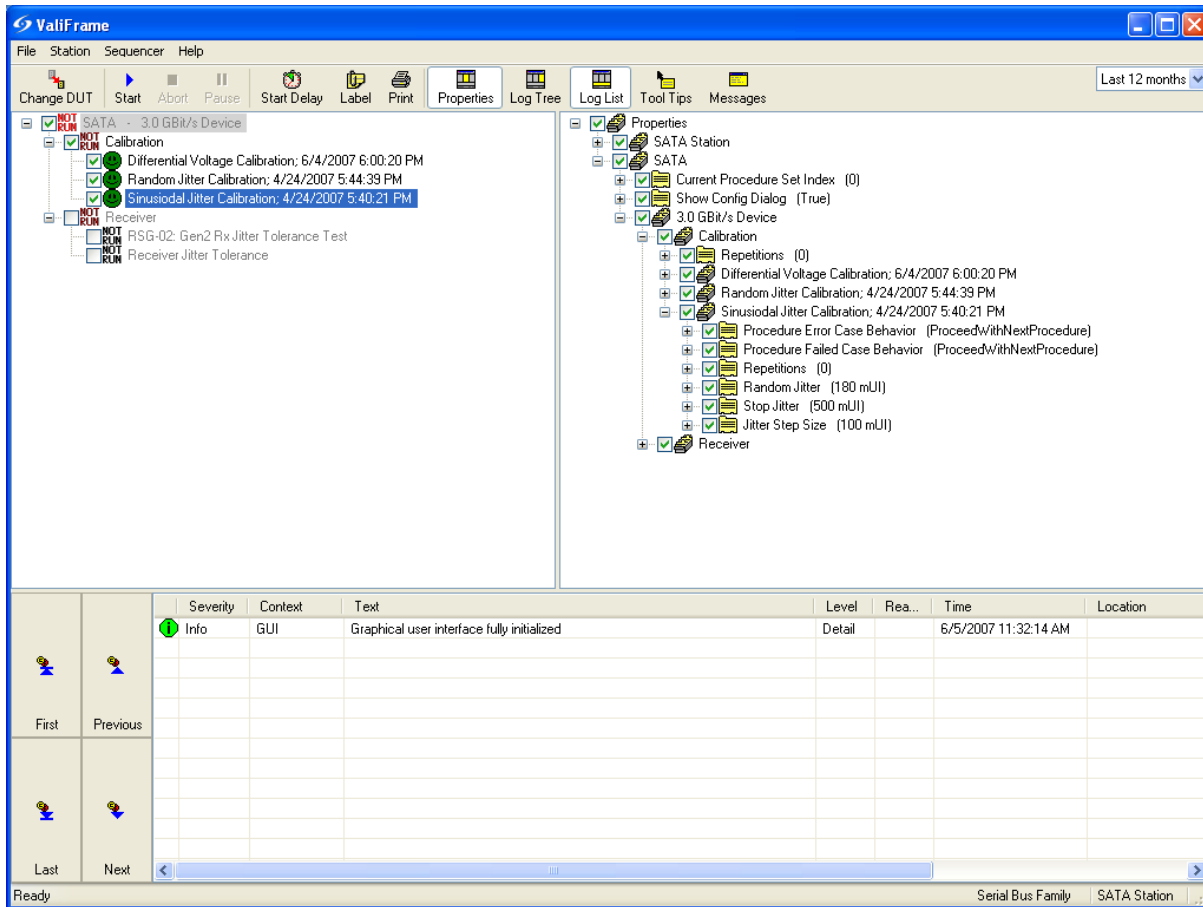

- Select “Differential Voltage Calibration”, “Random Jitter Calibration” and “Sinusoidal Jitter Calibration” from the test tree on the left side of the window.
- Press “Start”. Then you are prompted to change the electrical connection (according Appendix B – SSG Calibration Procedure using Keysight DSO081204 as the JMD).
- When the calibration procedures are finished the indicators next to the calibration routines should be green. The calibration routines should be performed once a day. The date and time of the last calibration is noted next to the calibration routines names in the test tree.

Serial ATA Logo Working Group

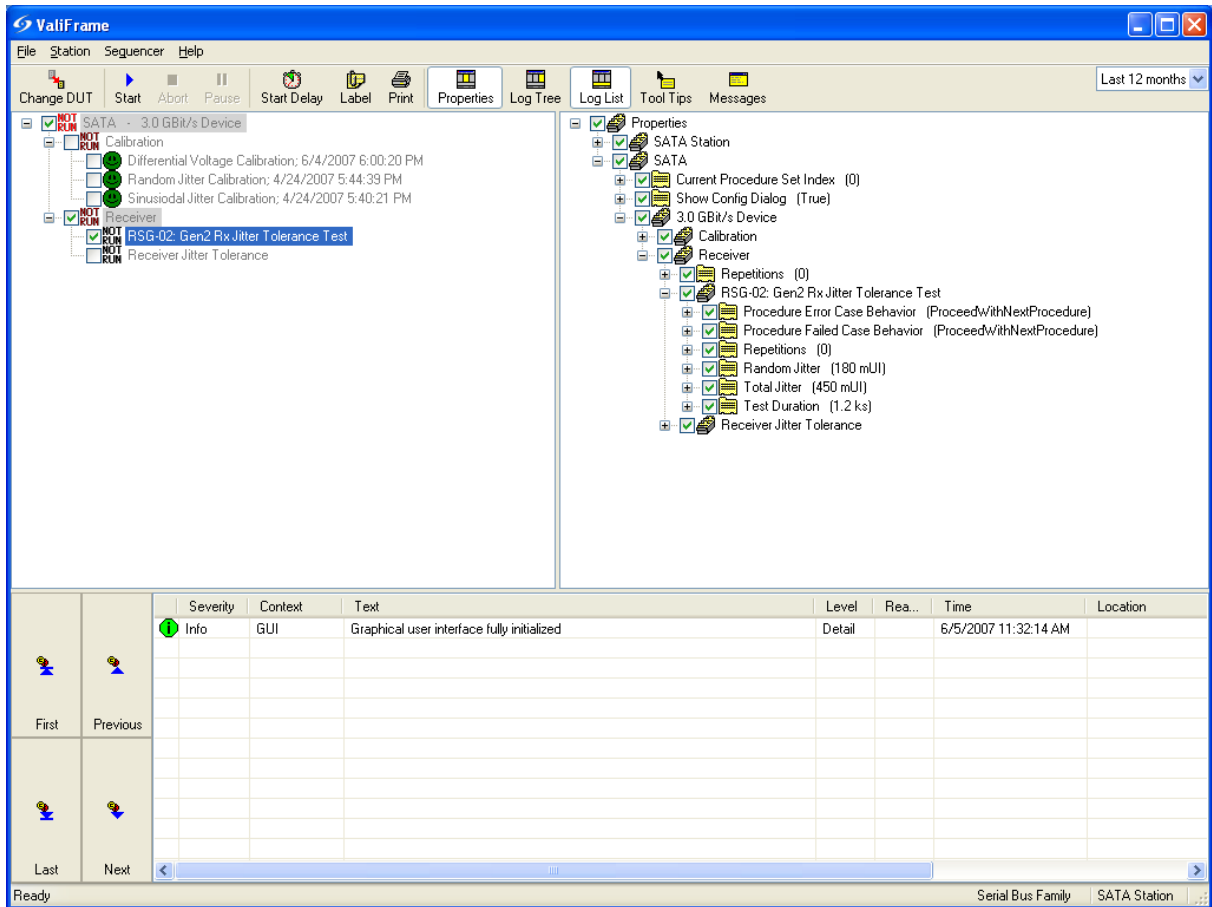

- Select the “RSG-02: Gen2 Rx Jitter Tolerance Test” procedure.
- Press “Start”. Then you are prompted to change the electrical connection (according group1 Test RSG-02) .
- After one hour the test RSG-02 is finished. When the green indicator next to the test name is green the DUT has passed the test. For a detailed test report double click on the test and an excel sheet will open:

Serial ATA Logo Working Group

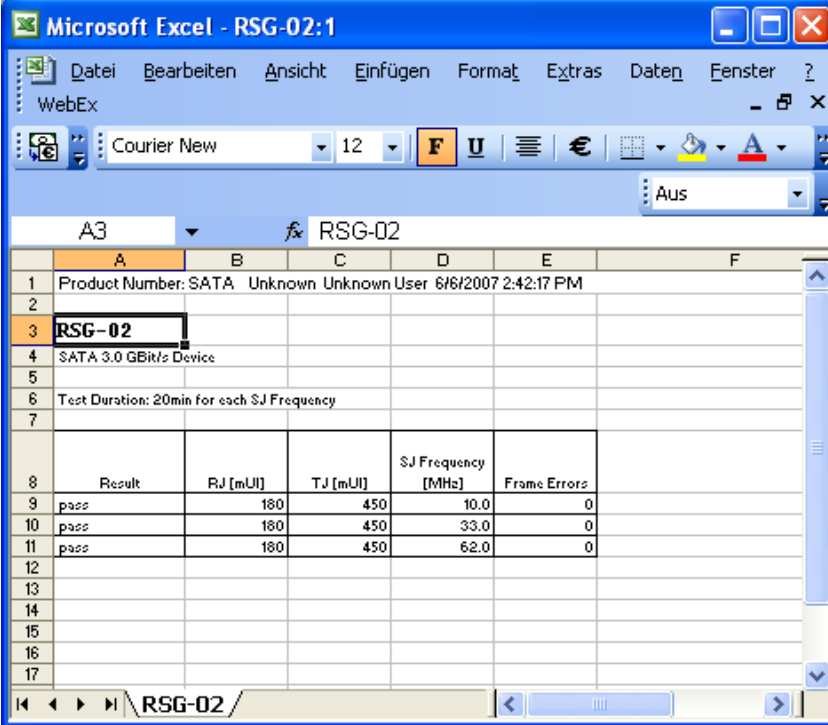

Microsoft Excel - RSG-02:1

WebEx

Courier New 12 F U €

A3 RSG-02

	A	B	C	D	E	F
1	Product Number: SATA Unknown Unknown User 6/6/2007 2:42:17 PM					
2						
3	RSG-02					
4	SATA 3.0 GBit/s Device					
5						
6	Test Duration: 20min for each SJ Frequency					
7						
8	Result	RJ [mUI]	TJ [mUI]	SJ Frequency [MHz]	Frame Errors	
9	pass	180	450	10.0	0	
10	pass	180	450	33.0	0	
11	pass	180	450	62.0	0	
12						
13						
14						
15						
16						
17						

RSG-02

K.3 – Test RSG-01: Gen 1(1.5Gb/s) Receiver Jitter Tolerance Test

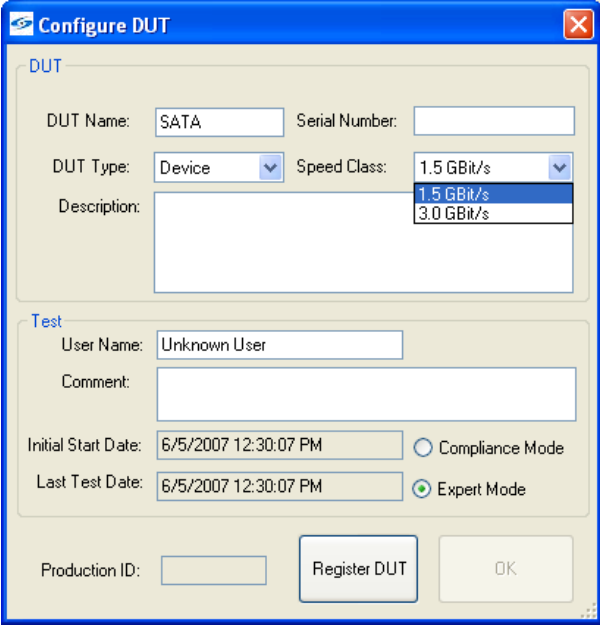

Configure DUT

DUT

DUT Name: SATA Serial Number: []

DUT Type: Device Speed Class: 1.5 GBit/s
1.5 GBit/s
3.0 GBit/s

Description: []

Test

User Name: Unknown User

Comment: []

Initial Start Date: 6/5/2007 12:30:07 PM Compliance Mode

Last Test Date: 6/5/2007 12:30:07 PM Expert Mode

Production ID: [] Register DUT OK

- Press “Configure DUT” or “Change DUT”
- Select “1.5 GBit/s” for Speed Class and press “Register DUT” and “OK”.
- Now proceed as described in J.2 Test RSG-02.

Serial ATA Logo Working Group

Appendix L – Using the Keysight 81133/4A Pulse/Pattern Generator and 81150A Pulse Function Arbitrary Noise Generator as the Stressed Signal Generator (SSG)

Purpose: To document the necessary setup and configuration procedures required when using the Keysight 81133A or 81134A-based system as the Stressed Signal Generator with the 81150A Pulse Function Arbitrary Noise Generator.

References:

- [1] Serial ATA Interoperability Program Revision 1.4 Unified Test Document, Section 2.17

Last Modification: August 8, 2009

Discussion:

There are multiple suitable options available for generating the stressing signal required for performing SATA Receiver Tolerance testing. One option is to use a system built around the Keysight 81133/4A Pulse/Pattern Generator as explained in Appendix G. In Appendix G the Keysight 33250A and a NoiseCom noise generator are used to generate the required jitter signals. In this appendix these jitter sources will be replaced by the Keysight 81150A Pulse Function Arbitrary Noise Generator. The procedures shown here use a dual channel configuration of the 81150A instrument. However if it's desired to keep one of the jitter sources mentioned in Appendix G either one can be replaced by the 81150A in a single or dual channel configuration.

This appendix documents the necessary procedures for setting up and configuring the system for RSG testing. (Note these procedures are referenced by other procedures in this document.)

L.1 – General SSG Setup:

The general setup using the 81134A and 81150A is shown below:

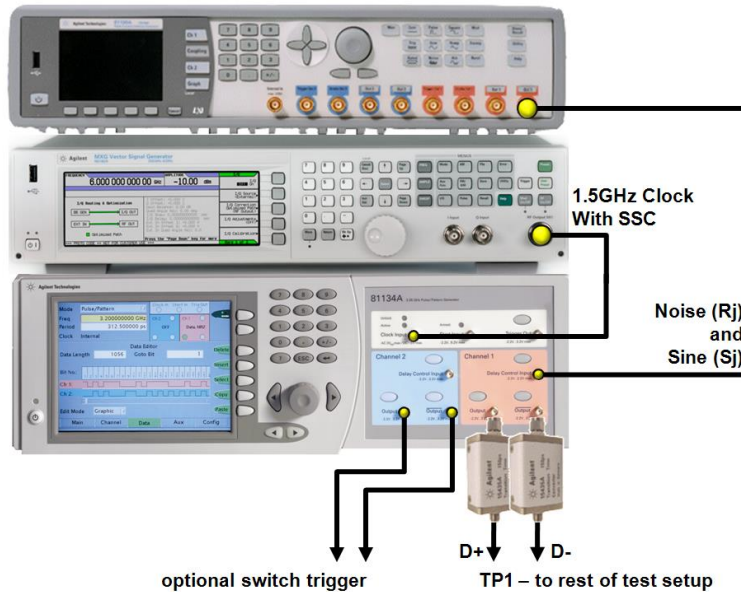

Figure L-1: Keysight 81134A Pulse and Pattern Generator, Keysight 81150A Pulse Function Arbitrary Noise Generator, and Keysight N5182A MXG RF Vector Signal Generator

Serial ATA Logo Working Group

Follow steps G.1 through G.3 in Appendix F. In addition make sure to connect output Out1 of the 81150A to the delay control input of the 81134A when using the 81150A to generate random noise and sinusoidal waveforms. If only one of the jitter signal shall be generated replace the respective generator in the setup shown in Appendix G.

L.2 – Adjusting the Random Jitter (RJ):

- To adjust the RJ turn on output 1 of the 81150A and make sure that the channel add feature is turned off. Select the Noise function and Crest Factor 7.0 in the PDF menu. Increase/decrease the output amplitude.
This step is the same if the 81150A replaces only the NoiseCom noise generator in the setup shown in Appendix G.

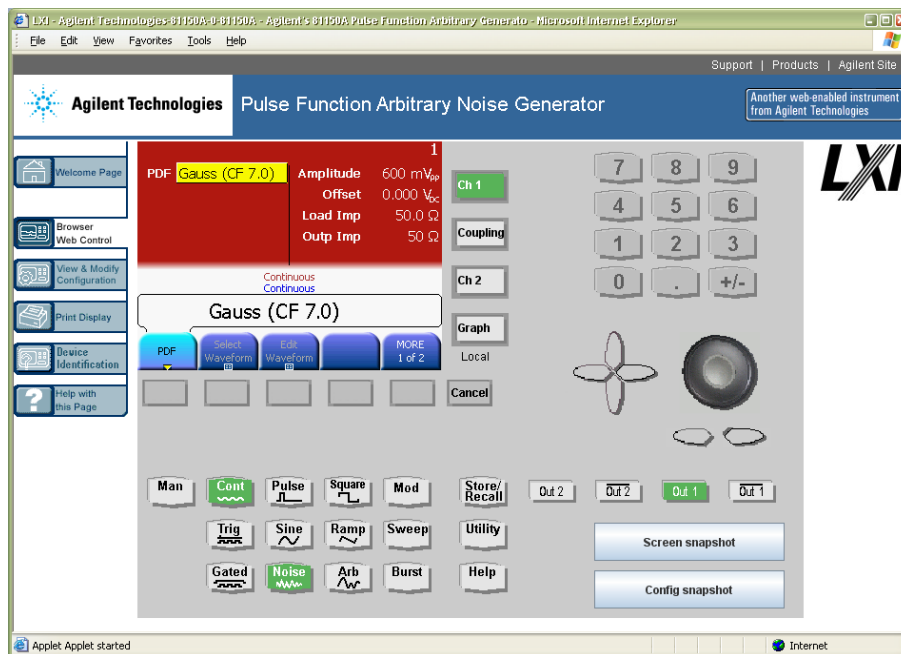

Figure L-2: Keysight 81150A remote interface with noise settings for channel 1 shown. The LXI interface pictures the local user interface and all front panel controls.

L.3 – Adjusting the Deterministic Jitter (DJ):

- To adjust the Deterministic Jitter via the 81150A turn on its channel add feature first. If the 33250A shall be replaced in a setup as described in Appendix F this step is not needed. Use the Utility menu to enter the Output Setup submenu. When the channel add feature is turned on the signal that is generated by channel two will be internally added to output one. No external power combiner will be needed.

Serial ATA Logo Working Group

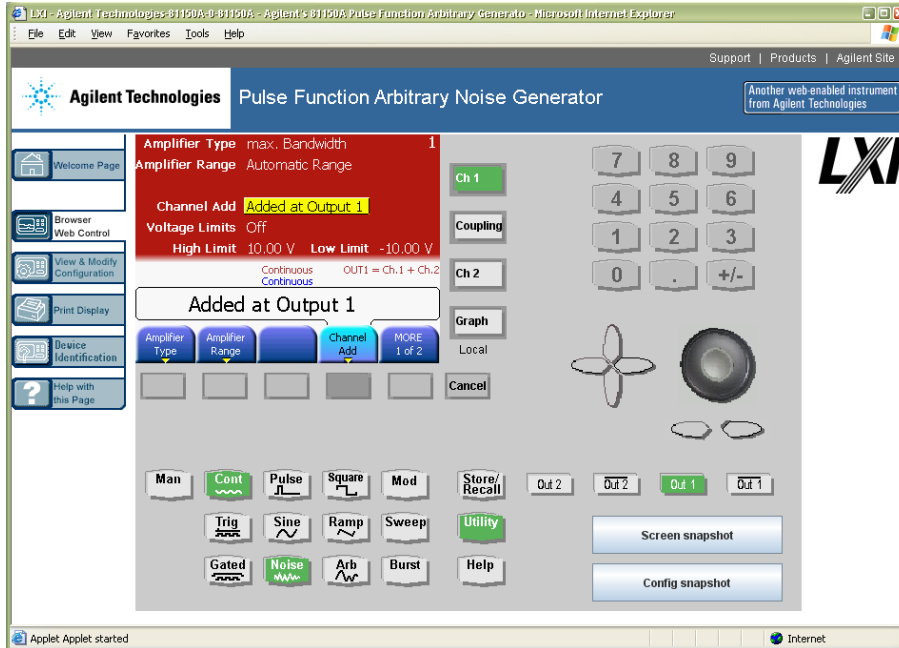

Figure L-3: Keysight 81150A remote interface with channel add feature turned on.

- Select channel 2 and sinusoidal waveform by pressing the Sine button. Use the Frequency hotkey to set the required frequency. Calibrate the deterministic jitter by adjusting the Amplitude and observing the jitter reading on the JMD.

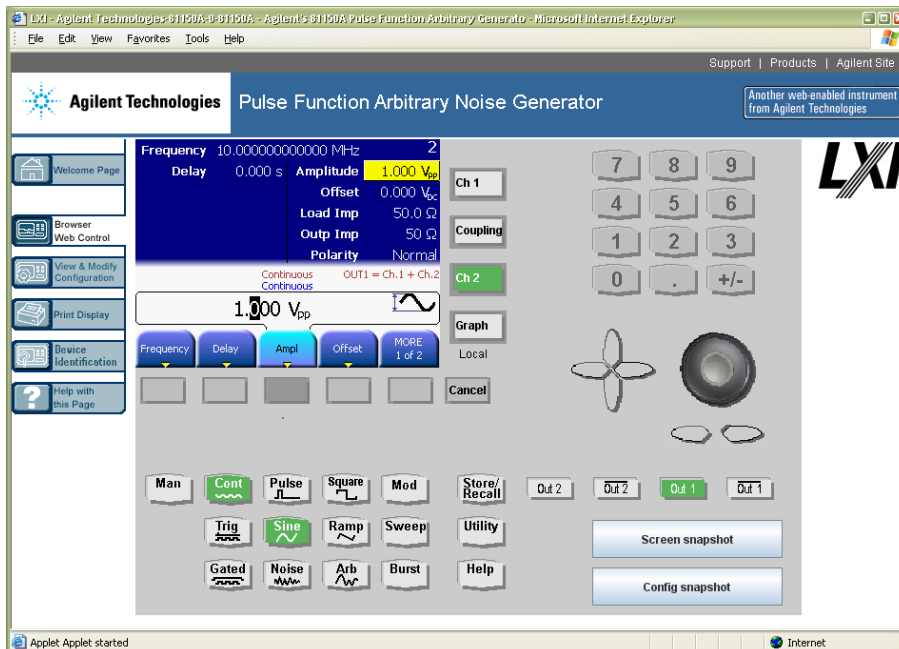

Figure L-4: Keysight 81150A remote interface with sinusoidal waveform configuration for channel 2 shown.

Appendix M – Using the Keysight J-BERT N4903B with Option A02 as the Frame Error Detector

Purpose: To document the necessary setup and configuration procedures required when using the Keysight J-BERT N4903B with option A02 as the frame error detector.

References:

[2] Serial ATA Interoperability Program Revision 1.4 Unified Test Document, Section 2.17

Last Modification: March 16, 2010

Discussion:

There are multiple suitable options available for detecting frame errors for SATA receiver tolerance testing. With option A02 the Keysight J-BERT B error detector recognizes 8B/10B coding and if enabled will do a symbol compare. In that mode it deals with running disparity and detects the data behind possible 10 bit codes. Furthermore option A02 recognizes SATA Aligns and removes them from the data stream before pattern compare.

The J-BERT error detector with option A02 may be used together with all Stressed Signal Generators (SSG) mentioned in this document. However since it is integrated as one instrument with the J-BERT B pattern generator that serves as a SSG it may be the most commonly used combination.

This appendix documents the necessary procedures for setting up and configuring the J-BERT B error detector with option A02 for RSG testing. (Note these procedures are referenced by other procedures in this document.)

M.1 – General Frame Error Detector Setup:

Connect the product under test transmitting the compliance pattern in BIST L to the input of the J-BERT error detector. Figure M-1 shows a single ended connection from a SATA test adapter to the error detector input. Use 50Ohm loads to terminate the unused lane. Alternatively a differential connection with a matched cable pair may be established.

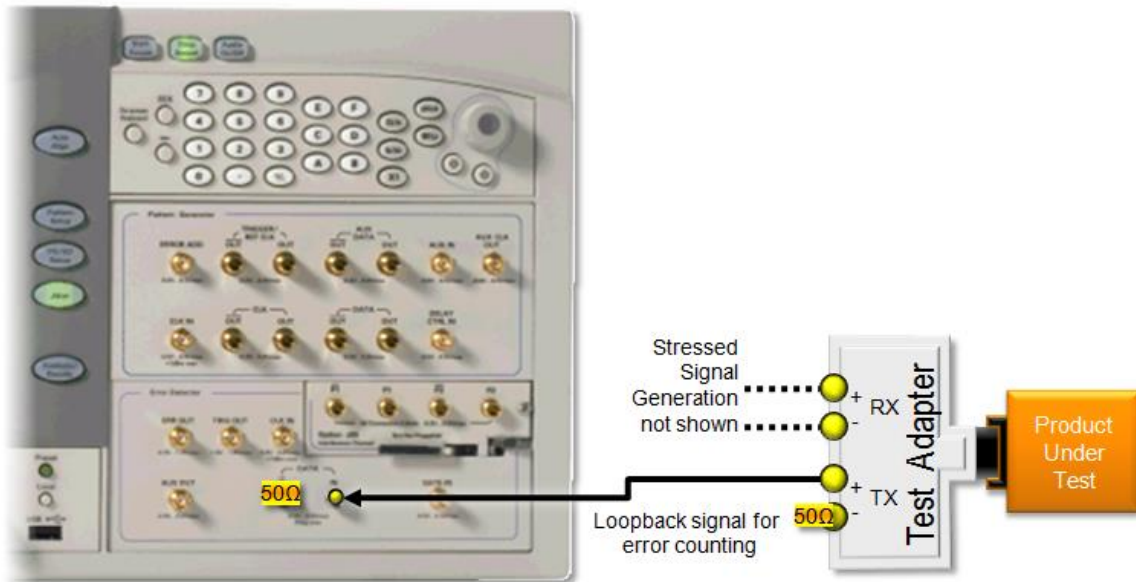

Figure M-1: Connection Diagram Using J-BERT Error Detector as the Frame Error Detector

Select the compliance pattern from the J-BERT pattern library and load it to the J_BERT error detector. Figure M-2 shows the pattern select dialog. If J-BERT is also used as Stressed Signal Generator the “Error Detector

Serial ATA Logo Working Group

tracks the Pattern Generator Pattern” checkbox might be checked. Otherwise the pattern files may be loaded individually.

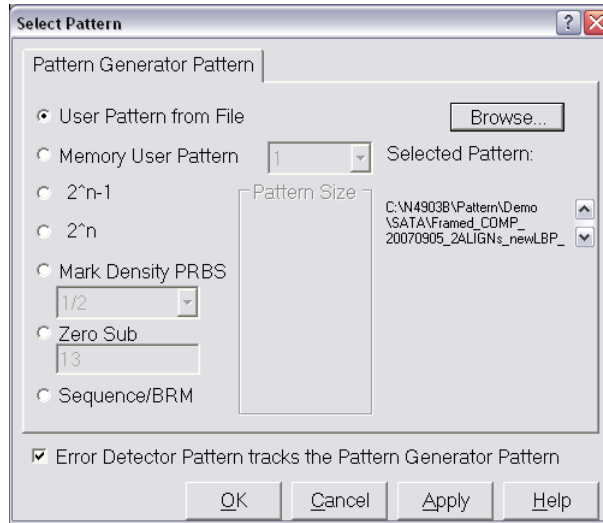

Figure M-2: J-BERT Pattern Select Dialog

Set the J-BERT Error Detector clock to Clock Data Recovery and specify the clock rate of the current test as specified in the UTD. Turn on SSC Tracking and set it according to the specification of the product under test. This should be either 0% or 0.5% downspread. Adjust the Loop Bandwidth and Peaking and measure the Transition Density until the CDR reliably tracks the clock of the product under test. This is achieved if the Clock Loss LED in the lower right area of the user interface is permanently off. A typical setting is 7.2MHz loop bandwidth, 67% transition density and the highest peaking.

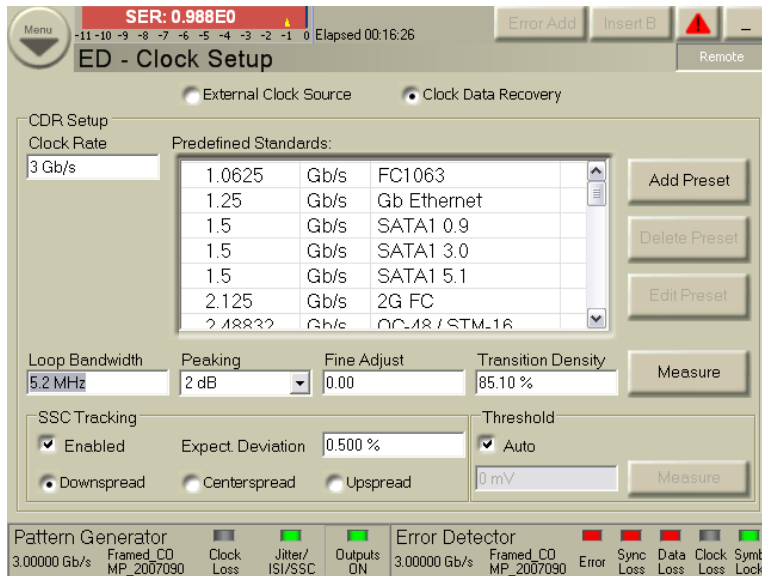

Figure M-3: J-BERT Error Detector Clock Setup Menu

Press the Auto Align button on the J-BERT front panel to let it automatically find the optimum sampling point for the Error Detector.

With option A02 the J-BERT Error Detector menu offers an Error Ratio submenu which allows to choose between BER measurements, Symbol Error Ratio and Frame Error Ratio measurements. For SATA compliance

Serial ATA Logo Working Group

select SER/FER and let J-BERT report the results as Frame Error Ratio (i.e. FER). Select SATA with ERM=FER from the list of pre-defined setups.

Once the Error Ratio settings are done the Symbol Lock LED in the lower right corner of the J-BERT user interface will light green to indicate that J-BERT has achieved symbol alignment.

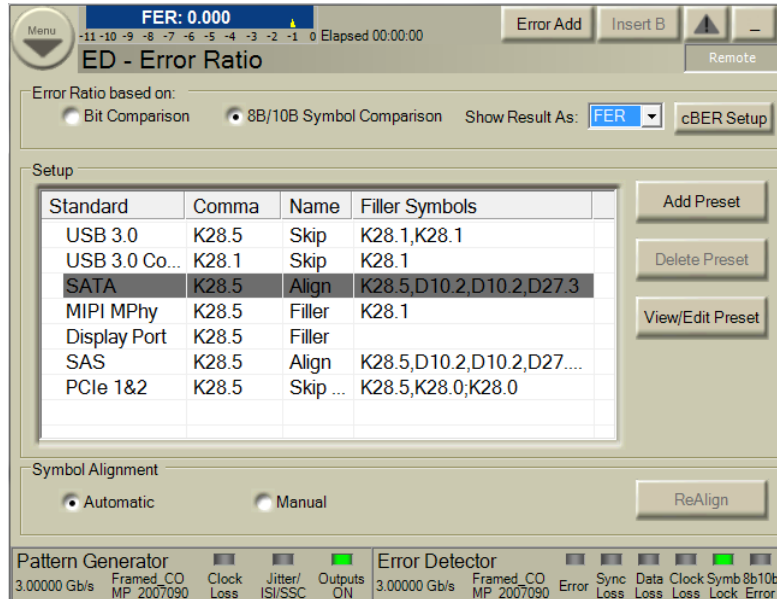

Figure M-4: J-BERT Error Ratio Menu

The compliance pattern is designed to be interoperable with various protocol analyzers. It includes portions that address protocol level requirements which should not be included into the receiver tolerance test. Therefore it is necessary to check only the included frame payload for errors. Use the Error Detector Bit Error Location Mode function to specify the frame payload part of the compliance pattern as the block to be used for frame error detection. Figure L-5 shows the dialog with the correct settings. Once the block is defined all error indicators of the Error Detector will turn off and the FER will be zero if no stress is applied by the stressed signal generator.

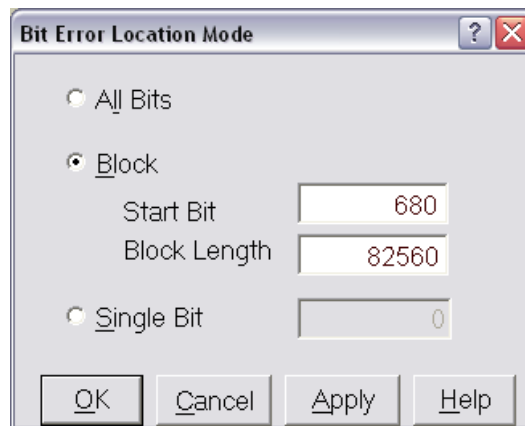

Figure M-5: J-BERT Bit Error Location Mode Dialog

Use the Accumulated Results screen to observe frame errors while running receiver tests. Use the Start and Stop buttons at the J-BERT front panel to let the error detector accumulate measurement results.

Serial ATA Logo Working Group

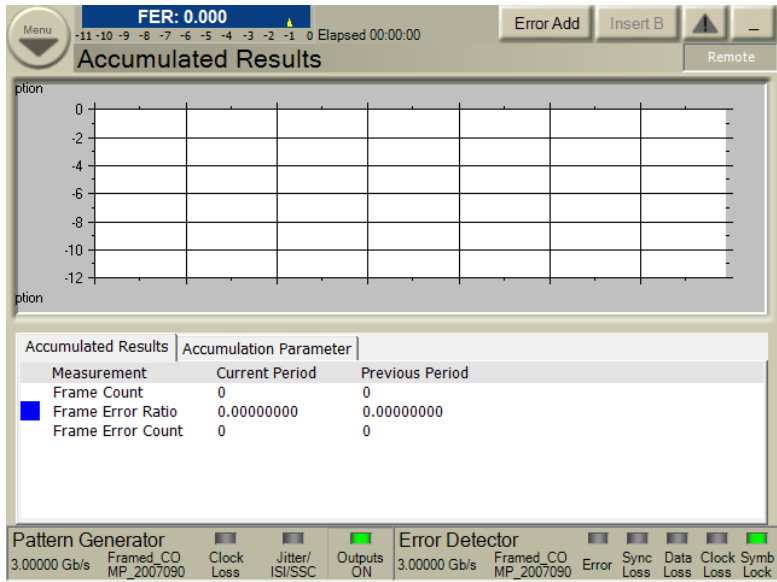

Figure M-6: J-BERT Accumulated Results Screen

Appendix N – Using the Keysight J-BERT M8020A with Option 0S2 as the Frame Error Detector

Purpose: To document the necessary setup and configuration procedures required when using the Keysight J-BERT M8020A with option 0S2 as the frame error detector.

References:

[1] Serial ATA Interoperability Program Revision 1.4 Unified Test Document, Section 2.17

Last Modification: March 16, 2010

Discussion:

There are multiple suitable options available for detecting frame errors for SATA receiver tolerance testing. With option 0S2 the Keysight J-BERT M8020A error detector recognizes 8B/10B coding and if enabled will do a symbol compare. In that mode it deals with running disparity and detects the data behind possible 10 bit codes. Furthermore option A02 recognizes SATA Aligns and removes them from the data stream before pattern compare.

The J-BERT error detector with option 0S2 may be used together with all Stressed Signal Generators (SSG) mentioned in this document. However since it is integrated as one instrument with the J-BERT pattern generator that serves as a SSG it may be the most commonly used combination.

This appendix documents the necessary procedures for setting up and configuring the J-BERT M8020A error detector with option 0S2 for RSG testing. (Note these procedures are referenced by other procedures in this document.)

M.1 – General Frame Error Detector Setup:

Connect the product under test transmitting the compliance pattern in BIST L to the input of the J-BERT error detector. Connect the M8041A error detector to the PUT TX differentially or single-ended. Use 500ohm loads to terminate the unused lane. Load the respective application preset for SATA by going to **Application->Serial ATA** This factory preset sets up the J-BERT M8020A with SATA patterns in the B8B10 format and automatically configures the BERT to perform error counting on a framed comp pattern. Whenever B8B10 patterns are used in the error detector sequence the J-BERT M8020A is setup to measure the SER/FER. Part of the SATA factory setting is the correct scrambler/de-scrambler and ALIGN primitive setup. The framed comp pattern within those setups is configured for FER counting. If N5990A-303 SATA Link Training Suite the J-BERT M8020A is used the J-BERT M8020A is setup correctly for SATA FER counting.

Serial ATA Logo Working Group

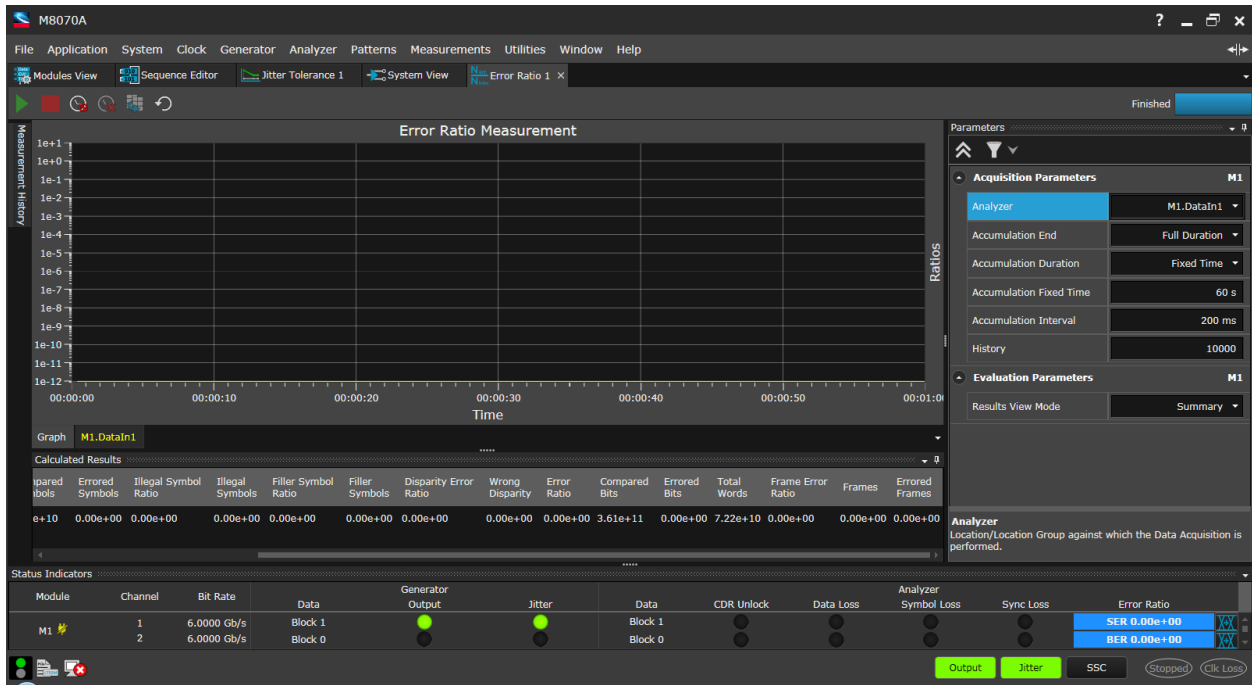

Figure M-1: J-BERT M8020A Error Ratio Measurement Screen